



DESIGN GUIDE

PURLINS AND GIRTS

CONTENTS

INTRODUCTION	2	IDENTIFICATION OF SPAN TYPE	7
Acknowledgements	2		
Disclaimer	2	DESIGN TABLES	
Product Technical Statement	3	UDL Span Tables	
		4.0m – 7.0m spans	8
GENERAL INFORMATION		7.5m – 10.5m spans	10
Introduction	5	11.0m – 14.0m spans	12
Description	5	14.5m – 17.5m spans	14
Materials/Finish	5	Axial Load Tables	16
Length	5	Bolt Joint Capacity	18
Tolerances	5	Splice Joints	19
Bracing	5	Sectional Properties	21
Durability	5	Section Capacities	21
Limitations	5		
DESIGN INFORMATION		DETAILING AND INSTALLATION	
Applicable Standards	6	Ordering	22
Design Assumptions	6	Section Geometry	22
Design Criteria	6	Purlin Dimensions	22
Roof Sheeting	6	Standard Hole Locations	23
Load Combinations	6	Bracing	24
Axial Compression and Bending	6	Standard Cleat Details	25
Purlin Torsion Restraint Check	6	Site Handling and Storage	25

INTRODUCTION

Steel & Tube is pleased to provide this *Purlins and Girts Design Guide* to assist you in the design and specification process for these products.

DISCLAIMER

This publication is intended to provide information to the best of our knowledge in regard to HST cold-formed sections. It does not constitute a complete description of the goods or an express statement about their suitability for any particular purpose. It is intended as a general guide and not as a substitute for professional technical advice.



North Island: 09 271 9280 | purlins@steelandtube.co.nz
South Island: 03 377 0994 | pch.christchurch@steelandtube.co.nz
www.steelandtube.co.nz

PRODUCT TECHNICAL STATEMENT (PTS) FOR STEEL & TUBE HST PURLINS AND GIRTS

(ALL BRACING COMPONENTS INCLUDED)

MANUFACTURER'S DETAILS:

Steel & Tube Holdings Limited.

PTS VERSION:

August 2022.

PRODUCT(S) COVERED:

High strength cold rolled **HST** purlins and girts manufactured by Steel & Tube:

- **HST** structural purlins.
- **HST** structural wall girts.
- All associated bracing and jointing components.

CBI REFERENCE:

3411 and 3412.

PRODUCT DESCRIPTION:

Steel & Tube's **HST** Purlins and Girts profiles are continuously cold roll formed from zinc coated high-tensile steel, punched in-line and cut-to-length. Accessories are also zinc-coated and are either made to custom lengths or supplied as a standard component.

SCOPE OF USE:

Steel & Tube's **HST** Purlins and Girts are a specific design product only and are intended for specialist structural steel construction only.

LIMITATIONS OF USE:

Neither this PTS nor our technical product Design Guide constitutes a complete description of the goods or expresses a statement about their suitability for a particular application. They are intended as a general guide and not as a substitute for professional technical advice.

All literature and design tables supplied are for Steel & Tube **HST** Purlins and Girts only. Steel & Tube does not accept liability for the incorrect use of the tables or its **HST** Purlins and Girts.

COMPLIANCE WITH THE NZ BUILDING CODE:

Steel & Tube **HST** Purlins and Girts are to be designed in accordance with AS/NZS 4600 and are manufactured from materials conforming to AS 1397. On this basis, they are expected to meet the performance objectives of the following Building Code Clauses:

The New Zealand Standard controls the mechanical properties of the coil used for the manufacture of the **HST** Purlins and Girts.

- B1 Structure – **HST** Purlins and Girts conform to clauses B1.1, B1.2, B1.3.1 B1.3.2, B1.3.3 of clause B1 of the NZBC (when used in accordance with this Design Guide).
- B2 Durability – **HST** Purlins and Girts conform to clauses B2.1, B2.2, B2.3.1, B2.3.2 of clause B2 of the NZBC (when used in accordance with our durability statement on page 5).
- F2 Hazardous Building Materials – **HST** Purlins and Girts conform to clause F2 of the NZBC.

It remains the responsibility of the designer to ensure that the appropriate version of any standards referenced in this document are adopted, based on the desired compliance pathway. Where a new (in draft or published) version of a standard is yet to be cited in a Verification Method, Steel & Tube recommends the more onerous design requirements of any conflicting clauses are adopted by a designer.

PRODUCT TECHNICAL STATEMENT (PTS) FOR STEEL & TUBE HST PURLINS AND GIRTS (CONTINUED)

(ALL BRACING COMPONENTS INCLUDED)

DESIGN AND INSTALLATION:

This comprehensive technical Steel & Tube **HST** Purlins and Girts Design Guide is made available to all specifiers and engineers in hard copy or via the company website.

Purlin and Girt loads are presented in Limit State format consistent with AS/NZS 1170.0 "Structural Design Actions". All the design information in this brochure should be used in conjunction with AS/NZS 4600.

Steel & Tube recommends the use of recognised designers and installers at all times.

QUALITY ASSURANCE:

Steel & Tube is committed to providing our customers with consistent and reliable quality products. To demonstrate this commitment, Steel & Tube is a Telarc registered supplier certified to ISO 9001.

All galvanised coil product is batch tested by suppliers to address all aspects of quality control and ongoing liaison with supply chain ensures quality product consistency.

In a dry internal environment the life expectancy of the **HST** range of products will exceed 50 years.

For applications exposed to moisture, salt spray or industrial contaminants, maintenance of the coating may be required to achieve a 50 year service life. Alternatively the purlins can be painted prior to erection in accordance with SNZ TS 3404.

Heavier zinc coating weights of 450 and 550 g/m² can also be provided.

PRODUCT SUPPORT:

Manufacturing of these products is located in both Auckland and Christchurch.

Steel & Tube offers full product technical support and backup via its national network of product specialists.

Consult our website www.steelandtube.co.nz for further information and assistance.

GENERAL INFORMATION

INTRODUCTION

Steel & Tube **HST** Steel Purlins and Girts are high-strength lipped profile sections manufactured by Steel & Tube, incorporating optimised enhancements to the traditional Cee shape. This brochure has been developed taking into consideration the trend towards more complex span configurations and varying end-uses of lightweight cold-formed sections, to give easier and more accurate access to design information for different applications.

The load tables have been generated using computer programs Purlin and Purlin 4600, enabling a more thorough analysis of cold-formed purlin capacities in differing load cases and combinations.

DESCRIPTION

Steel & Tube's **HST** sections are continuously rollformed from zinc coated high-tensile steel, punched in-line and cut-to-length. Accessories are also zinc-coated and are either made to custom lengths or supplied as a standard component.

The optimized dimensions of **HST** purlins, together with the widest range of depths and thicknesses, make **HST** purlins the top performer in lightweight cold-formed steel sections.

MATERIALS/FINISH

HST Purlins and Girts are rolled from galvanised high strength steel strip complying with AS 1397, in the following thicknesses and grades:

STEEL THICKNESS	GRADE	ZINC WEIGHT*
1.15 – 1.45mm	G500 (MPa)	275 g/m ²
1.75 - 3.0mm	G450 (MPa)	275 g/m ²

*Other coating weights are available subject to supply considerations. Refer: Durability.

The load tables are formulated using the minimum yield strength and ultimate strength for the specified grade, which is below typical yield strength achieved with these materials.

TOLERANCES

Web Depth ± 2mm	Flange Width ± 2mm
Lip ± 1mm	Hole Centers ± 1.5mm
Web/Flange Angle 88-93°	Length ± 3mm

Some acceptable “bell mouching” outside these tolerances may occur at the ends of a purlin as a result of the manufacturing process.

BRACING

The **HST** Purlin and Girt system utilises speed channel or bolted braces as required by the design procedure on page 6. The use of sag rods is not recommended without specific engineering design.

All **HST** brace channels are cut to length with end-brackets custom fitted to suit the purlin size and spacing. All bracing components are fabricated from grade G250 galvanised steel.

Brace channel is 100 x 32 lipped channel in 0.95 thickness.

DURABILITY

In a dry internal environment, service life will exceed 50 years, complying with the durability requirements of NZBC Clause B2 – Durability.

For applications exposed to moisture, salt spray or industrial contaminants, maintenance of the coating may be required to achieve a 50 year service life, or the purlins can be painted prior to erection in accordance with SNZ TS 3404.

Heavier zinc coating weights of 450 and 550 g/m² can also be provided, subject to minimum order quantity and lead times.

Please refer to New Zealand Steel Durability and Maintenance statement for Galvanised Steel.

LIMITATIONS

These documents and tables only apply to Steel & Tube **HST** purlins.

DESIGN INFORMATION

APPLICABLE STANDARDS

HST Purlin and Girt loads are presented in Limit State format consistent with AS/NZS 1170.0 "Structural Design Actions". All the design information in this brochure should be used in conjunction with AS/NZS 4600.

DESIGN ASSUMPTIONS

The load capacities given in the "Ultimate Uniformly Distributed Load" tables are the design load capacities for ultimate limit state ($\phi_b w_{bX}$) in kilonewtons per metre of span (kN/m) where uniformly distributed loads are continuous along the full span.

The purlin capacities in the **HST** load-span tables (including deflection) are based on the assumption of sufficient purlin restraint.

A suitably qualified structural engineer shall verify that appropriate lateral and torsional restraint is supplied. For other load situations, specific design is required. Loads for intermediate spans may be determined by linear interpolation.

The purlins are supported by cleat plates and no bolt slip or member rotation has been allowed at fixed points. Where the axial load applies, the engineer should check the bolt capacity.

The serviceability load capacities (w_s) are the uniformly distributed load (kN/m) at which the midspan deflection equals span/150. Deflections at other loads can be determined by direct proportion and corresponding serviceability limit states checked accordingly. The serviceability load capacities are calculated by using the average of the gross and effective second moment of area.

All designs of the **HST** purlin system must be checked for sufficient bracing as per the purlin torsion restraint check on this page to ensure that the capacities in the purlin load-span tables can be achieved.

DESIGN CRITERIA

Strength reduction factors are included in the design load capacity and have been determined from AS/NZS 4600 as follows:

Bending $\phi_b = 0.90$ ($\phi_b = 0.95$ for section moment capacity)

Compression $\phi_c = 0.85$

Shear $\phi_v = 0.90$

The self-weight of **HST** purlin is not included in the load tables and should be calculated along with other dead loads.

ROOF SHEETING

Screw-fastened sheeting which is regularly attached to one flange of the purlins or girts, provides a continuous diaphragm shear restraint against minor axis rotation Kry (but no torsional restraint). This has been assumed in determining the "Ultimate Uniformly Distributed Load" and the "Ultimate Axial Compression Load" tables. A value for Kry of 100,000 Nmm/mm is used. If clip-fastened sheeting is fixed to purlin, specific design is required.

LOAD COMBINATIONS

The Limit State method of design is recommended with combinations of factored loads for each limit state in accordance with AS/NZS 1170. This should include permanent, imposed, wind, snow, earthquake and other loads.

Loads are assumed to act at the flange where the cladding is attached. For roof pitches over 10°, the design engineer shall allow for the resultant force in the plane of the roof due to dead, live and snow loads.

For walls, provided the maximum spacing between brace struts is limited to 3000 mm and the wall cladding is screw fixed to the girts, the dead load of the girts and cladding may be assumed to be carried directly by the bracing system. Accordingly, the girts may be designed for face loads only. The design engineer should ensure that the loads in the bracing system can be supported either by an eaves member or directly by the foundations.

AXIAL COMPRESSION LOADS AND COMBINED BENDING AND AXIAL COMPRESSION ACTIONS

The load capacities given in "Ultimate Axial Compression Load" tables are the design load capacities for ultimate limit state ($\phi_c N_c$) in kilonewtons (kN) for axial compression forces passing through the centroid of the simply supported **HST** section. The elastic buckling loads (N_e) in kilonewtons (kN) are also included.

Where **HST** purlins are required to support axial compression loads as well as bending loads, such as when they act as bracing struts or are required to transmit end wall loads to the roof bracing system, the designer shall consider the combined action requirement set-out in AS/NZS 4600. Note specifically the limitations on slenderness for members loaded in axial compression.

Note the **HST** purlin is assumed to have zero distribution load about the Y axis of bending. Where biaxial bending occurs, then specific guidance should be sought from Steel & Tube.

Refer to AS/NZS 4600 for axial tension and combined bending and axial tension design.

PURLIN TORSION RESTRAINT CHECK

The purlin capacities in the **HST** load-span tables (including those for deflection) assume there is sufficient brace capacity. This assumption may not be correct for some building configurations. Therefore a suitably qualified structural engineer shall apply this specific bracing check to all designs.

Step 1: Assessment of sheeting restraint to purlins

Is one flange of each of the purlins restrained by roof sheeting in a manner which meets the restraint requirements set out in AS/NZS4600:2005(A1)?

Adequate restraint achieved: $r=0.5$

Adequate restraint not achieved: $r=1.0$

Step 2: Determine tributary length of purlin to be restrained by each brace

This is the distance between the centre-points of the adjacent unrestrained purlin sections.

For example, a 7m purlin with one brace has two, 3.5m unrestrained lengths. The tributary length, l_t , distance between the centre-points of these unrestrained lengths, is 3.5m.

Step 3. Determine the values of $\phi_b w_b$, and x_s from the Steel & Tube Design Guide

NB: Divide x_s by 1000 to be in metres. Design Load w^* may be used instead of $\phi_b w_b$.

Step 4: Determine the bending moment on the brace

$M^* = 1.5 r \phi_b w_b l_t x_s / 2$ NB: Assumes continuous bracing lines. If purlin is not braced from both sides, do not divide by 2.

Step 5: Ensure the brace moment demand is less than the brace capacity

If purlin spacing is less or equal to 3.2m, brace moment capacity is 0.5 kNm

If purlin spacing is greater than 3.2 specific design is required.

IDENTIFICATION OF SPAN TYPE

SINGLE SPAN

A Single Span occurs where a purlin is simply supported between supports.



DOUBLE SPAN

A Double Span condition exists where purlins are continuous over two spans. Where a lapped Double Span occurs, specific design is required.



CONTINUOUS SPAN

Continuous Spans are generally achieved by splicing the ends of abutting purlins at a point in their span where moment is close to zero, typically 25% of span approximately. A standard connection splice is shown on page 21.

Continuous Span End. End spans refer to the first and last two spans of any continuous run.

Continuous Span Internal. Internal spans are spans beyond two ends of a continuous run.

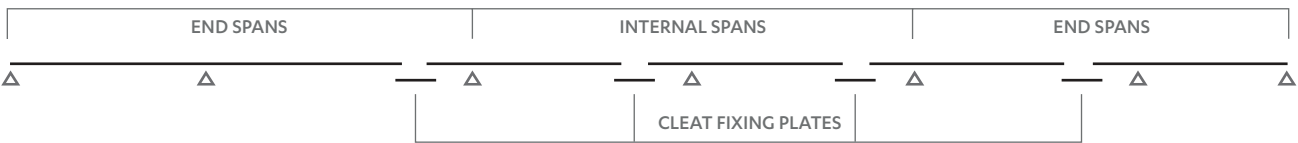

LAPPED SPAN

Lapped spans occur where purlins are lapped over supports. The minimum lap length is the greater of 10% (or 20%) of the span or 300mm each side of the support.

Lapped Span End. This applies to the first and last two spans of any continuous run. Figures are given for end spans lapped 10% and 20%.

Lapped Span Internal. This span type occurs where purlins are lapped 10% of their span over supports in internal bays. Figures are given for 10% laps; figures for other lap lengths are available on request.

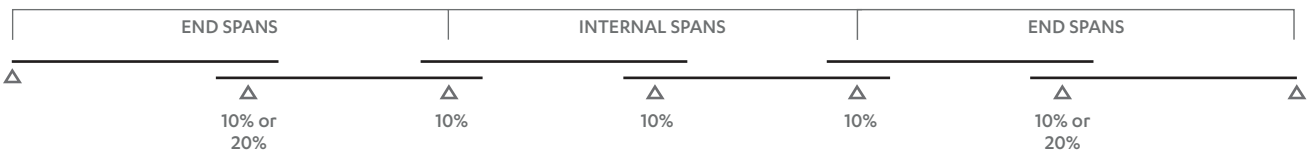

Lap length is distance between two outermost bolts.

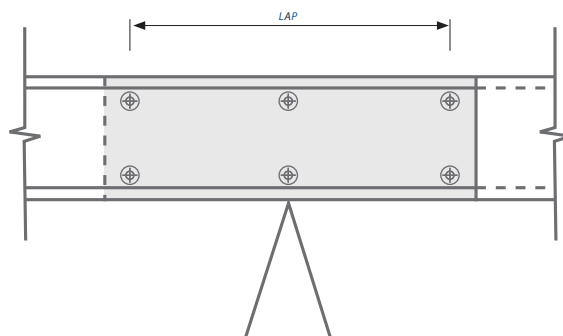

DESIGN TABLES

ULTIMATE UNIFORMLY DISTRIBUTED LOAD: 4.0 – 7.0 M

SPAN (M)		HST 150/12				HST 150/15				HST 150/18				HST 200/12				HST 200/15			
		$\phi_b w_{bx}$		w_s		$\phi_b w_{bx}$		w_s		$\phi_b w_{bx}$		w_s		$\phi_b w_{bx}$		w_s		$\phi_b w_{bx}$		w_s	
		(kN/m)				(kN/m)				(kN/m)				(kN/m)				(kN/m)			
SPAN	(M)	OB	1B	2B	DEF	OB	1B	2B	DEF	OB	1B	2B	DEF	OB	1B	2B	DEF	OB	1B	2B	DEF
SINGLE SPAN	4.0	2.00	3.01	3.01	2.08	2.64	4.09	4.09	2.67	3.17	4.87	4.87	3.26	3.56	4.35	4.35	4.45	4.79	5.98	5.98	5.72
	4.5	1.31	2.36	2.38	1.46	1.70	3.23	3.23	1.87	2.04	3.80	3.85	2.29	2.38	3.44	3.44	3.12	3.16	4.72	4.72	4.02
	5.0	0.90	1.82	1.93	1.06	1.14	2.49	2.62	1.37	1.38	2.93	3.12	1.67	1.63	2.78	2.78	2.28	2.15	3.83	3.83	2.93
	5.5	0.63	1.42	1.59	0.80	0.80	1.93	2.17	1.03	0.97	2.29	2.58	1.25	1.16	2.30	2.30	1.71	1.52	3.16	3.16	2.20
	6.0	0.46	1.11	1.34	0.62	0.58	1.50	1.82	0.79	0.71	1.78	2.17	0.97	0.84	1.87	1.93	1.32	1.09	2.56	2.66	1.70
	6.5	0.34	0.87	1.14	0.48	0.43	1.16	1.55	0.62	0.53	1.39	1.84	0.76	0.63	1.49	1.65	1.04	0.81	2.04	2.26	1.33
	7.0	0.26	0.68	0.95	0.39	0.33	0.90	1.31	0.50	0.41	1.08	1.54	0.61	0.48	1.20	1.42	0.83	0.61	1.62	1.95	1.07
DOUBLE SPAN	4.0	2.96	2.96	2.96	4.99	3.95	4.09	4.09	6.41	4.51	4.87	4.87	7.83	3.38	3.38	3.38	10.70	5.52	5.52	5.52	13.76
	4.5	2.31	2.38	2.38	3.51	3.05	3.23	3.23	4.50	3.48	3.85	3.85	5.50	2.86	2.86	2.86	7.51	4.59	4.59	4.59	9.66
	5.0	1.84	1.93	1.93	2.56	2.41	2.62	2.62	3.28	2.75	3.12	3.12	4.01	2.45	2.45	2.45	5.48	3.64	3.83	3.83	7.04
	5.5	1.49	1.59	1.59	1.92	1.95	2.17	2.17	2.47	2.23	2.58	2.58	3.01	2.12	2.12	2.12	4.11	2.94	3.16	3.16	5.29
	6.0	1.19	1.34	1.34	1.48	1.60	1.82	1.82	1.90	1.83	2.17	2.17	2.32	1.85	1.85	1.85	3.17	2.41	2.66	2.66	4.08
	6.5	0.96	1.14	1.14	1.16	1.29	1.55	1.55	1.49	1.52	1.85	1.85	1.82	1.56	1.63	1.63	2.49	2.01	2.26	2.26	3.21
	7.0	0.78	0.97	0.98	0.93	1.04	1.34	1.34	1.20	1.24	1.57	1.59	1.46	1.30	1.42	1.42	2.00	1.69	1.95	1.95	2.57
CONTINUOUS END	4.0	3.32	3.32	3.32	3.93	4.39	4.78	4.78	5.05	5.02	5.68	5.68	6.16	3.64	3.64	3.64	8.42	6.06	6.06	6.06	10.82
	4.5	2.59	2.72	2.72	2.76	3.37	3.77	3.77	3.54	3.84	4.49	4.49	4.33	3.10	3.10	3.10	5.91	5.07	5.07	5.07	7.60
	5.0	2.04	2.25	2.25	2.01	2.66	3.06	3.06	2.58	3.02	3.64	3.64	3.15	2.67	2.67	2.67	4.31	3.99	4.30	4.30	5.54
	5.5	1.58	1.86	1.86	1.51	2.13	2.53	2.53	1.94	2.42	3.01	3.01	2.37	2.33	2.33	2.33	3.24	3.19	3.69	3.69	4.16
	6.0	1.22	1.56	1.56	1.16	1.62	2.12	2.12	1.50	1.93	2.51	2.53	1.83	2.04	2.04	2.04	2.49	2.60	3.10	3.10	3.21
	6.5	0.93	1.29	1.33	0.92	1.22	1.76	1.81	1.18	1.47	2.07	2.15	1.44	1.64	1.81	1.81	1.96	2.15	2.64	2.64	2.52
	7.0	0.71	1.07	1.15	0.73	0.93	1.46	1.56	0.94	1.12	1.72	1.86	1.15	1.28	1.61	1.61	1.57	1.70	2.28	2.28	2.02
CONTINUOUS INTERNAL	4.0	4.05	4.05	4.05	8.56	5.42	5.91	5.91	11.00	6.20	7.03	7.03	13.43	4.39	4.39	4.39	18.34	7.35	7.35	7.35	23.59
	4.5	3.19	3.33	3.33	6.01	4.16	4.67	4.67	7.72	4.74	5.56	5.56	9.43	3.75	3.75	3.75	12.88	6.16	6.16	6.16	16.57
	5.0	2.51	2.78	2.78	4.38	3.27	3.78	3.78	5.63	3.71	4.50	4.50	6.87	3.24	3.24	3.24	9.39	4.92	5.24	5.24	12.08
	5.5	1.94	2.30	2.30	3.29	2.61	3.13	3.13	4.23	2.98	3.72	3.72	5.17	2.82	2.82	2.82	7.06	3.93	4.50	4.50	9.07
	6.0	1.50	1.93	1.93	2.54	2.00	2.63	2.63	3.26	2.38	3.10	3.13	3.98	2.48	2.48	2.48	5.43	3.20	3.84	3.84	6.99
	6.5	1.16	1.58	1.65	1.99	1.54	2.17	2.24	2.56	1.85	2.55	2.66	3.13	2.02	2.20	2.20	4.27	2.64	3.27	3.27	5.50
	7.0	0.90	1.31	1.42	1.60	1.19	1.79	1.93	2.05	1.43	2.11	2.30	2.51	1.59	1.96	1.96	3.42	2.14	2.82	2.82	4.40
LAPPED 10% END	4.0	4.12	4.33	4.33	4.18	5.23	6.45	6.45	5.37	5.89	7.67	7.67	6.55	4.37	4.37	4.37	8.95	7.54	7.54	7.55	11.51
	4.5	3.09	3.48	3.48	2.92	3.90	4.91	4.91	3.75	4.38	5.84	5.84	4.58	3.69	3.68	3.68	6.25	5.78	6.23	6.23	8.04
	5.0	2.40	2.84	2.84	2.12	3.01	3.86	3.86	2.72	3.37	4.60	4.60	3.32	3.15	3.15	3.15	4.54	4.42	5.23	5.23	5.84
	5.5	1.82	2.29	2.29	1.59	2.39	3.12	3.12	2.04	2.66	3.71	3.71	2.49	2.72	2.73	2.72	3.40	3.47	4.44	4.44	4.37
	6.0	1.34	1.84	1.89	1.22	1.75	2.52	2.57	1.56	2.10	2.95	3.06	1.91	2.28	2.38	2.38	2.61	2.79	3.76	3.76	3.35
	6.5	1.01	1.50	1.61	0.96	1.31	2.05	2.19	1.23	1.56	2.42	2.61	1.50	1.81	2.11	2.11	2.05	2.29	3.20	3.20	2.64
	7.0	0.77	1.23	1.39	0.77	0.99	1.68	1.89	0.98	1.19	1.99	2.25	1.20	1.40	1.89	1.89	1.64	1.84	2.76	2.76	2.11
LAPPED 20% END	4.0	4.13	4.75	4.75	4.23	5.24	6.70	6.70	5.44	5.95	7.98	7.98	6.64	4.39	4.63	4.64	9.07	7.57	8.11	8.11	11.66
	4.5	3.10	3.87	3.87	2.97	3.91	5.28	5.28	3.82	4.46	6.28	6.28	4.66	3.71	4.01	4.01	6.37	5.78	6.92	6.92	8.19
	5.0	2.41	3.14	3.14	2.16	3.02	4.27	4.27	2.78	3.44	5.08	5.08	3.40	3.18	3.52	3.51	4.64	4.42	5.97	5.97	5.97
	5.5	1.82	2.52	2.59	1.63	2.39	3.45	3.52	2.09	2.71	4.05	4.19	2.55	2.74	3.11	3.10	3.48	3.48	5.13	5.13	4.48
	6.0	1.34	2.02	2.17	1.25	1.76	2.76	2.96	1.61	2.18	3.25	3.52	1.96	2.29	2.76	2.76	2.68	2.79	4.31	4.31	3.45
	6.5	1.01	1.63	1.85	0.98	1.32	2.22	2.52	1.26	1.64	2.63	3.00	1.55	1.82	2.48	2.47	2.11	2.29	3.68	3.68	2.71
	7.0	0.77	1.32	1.60	0.79	1.00	1.79	2.17	1.01	1.25	2.13	2.57	1.24	1.41	2.22	2.23	1.69	1.85	3.05	3.17	2.17
LAPPED 10% INTERNAL	4.0	5.46	5.46	5.46	9.64	7.16	8.59	8.59	12.39	8.06	10.55	10.55	15.13	5.44	5.44	5.45	20.67	9.44	9.44	9.44	26.58
	4.5	4.17	4.38	4.38	6.64	5.26	6.66	6.66	8.54	5.90	7.92	7.92	10.42	4.58	4.58	4.58	14.24	7.78	7.78	7.78	18.31
	5.0	3.20	3.59	3.60	4.75	4.02	5.18	5.18	6.10	4.49	6.16	6.16	7.45	3.92	3.92	3.92	10.17	5.88	6.54	6.54	13.08
	5.5	2.40	2.98	2.98	3.53	3.15	4.15	4.15	4.53	3.52	4.90	4.93	5.54	3.38	3.38	3.38	7.56	4.58	5.54	5.54	9.73
	6.0	1.79	2.41	2.50	2.68	2.40	3.30	3.40	3.45	2.82	3.88	4.04	4.21	2.95	2.95	2.95	5.75	3.65	4.75	4.75	7.39
	6.5	1.36	1.96	2.13	2.11	1.79	2.68	2.89	2.71	2.14	3.16	3.44	3.31	2.42	2.63	2.63	4.52	3.00	4.18	4.18	5.82
	7.0	1.04	1.61	1.83	1.69	1.36	2.19	2.50	2.17	1.63	2.60	2.97	2.65	1.88	2.35	2.35	3.62	2.49	3.64	3.64	4.66

ULTIMATE UNIFORMLY DISTRIBUTED LOAD: 4.0 – 7.0 M

SPAN		HST 200/18				HST 250/13				HST 250/15				HST 250/18				HST 300/15			
		$\phi_b W_{bx}$			w_s	$\phi_b W_{bx}$			w_s	$\phi_b W_{bx}$			w_s	$\phi_b W_{bx}$			w_s	$\phi_b W_{bx}$			w_s
		(kN/m)				(kN/m)				(kN/m)				(kN/m)				(kN/m)			
(M)	0B	1B	2B	DEF	1B	2B	3B	DEF	1B	2B	3B	DEF	1B	2B	3B	DEF	1B	2B	3B	DEF	
SINGLE SPAN	4.0	5.83	7.18	7.18	7.02	6.17	6.17	6.17	8.66	8.27	8.27	8.27	10.20	10.00	10.00	10.00	12.54	7.43	7.43	7.43	17.14
	4.5	3.93	5.67	5.67	4.93	5.33	5.33	5.33	6.08	6.53	6.53	6.53	7.16	7.90	7.90	7.90	8.81	6.60	6.60	6.60	12.03
	5.0	2.62	4.59	4.59	3.60	4.32	4.32	4.32	4.43	5.29	5.29	5.29	5.22	6.40	6.40	6.40	6.42	5.94	5.94	5.94	8.77
	5.5	1.82	3.80	3.80	2.70	3.57	3.57	3.57	3.33	4.37	4.37	4.37	3.92	5.29	5.29	5.29	4.82	5.34	5.34	5.34	6.59
	6.0	1.31	3.05	3.19	2.08	3.00	3.00	3.00	2.56	3.68	3.68	3.68	3.02	4.44	4.44	4.44	3.72	4.49	4.49	4.49	5.08
	6.5	0.97	2.45	2.72	1.64	2.55	2.55	2.55	2.02	3.13	3.13	3.13	2.38	3.79	3.79	3.79	2.92	3.83	3.83	3.83	3.99
	7.0	0.73	1.97	2.34	1.31	2.15	2.20	2.20	1.62	2.63	2.70	2.70	1.90	3.15	3.27	3.27	2.34	3.30	3.30	3.30	3.20
DOUBLE SPAN	4.0	6.93	7.18	7.18	16.88	4.28	4.28	4.28	20.81	6.06	6.06	6.06	24.52	8.76	8.76	8.76	30.15	5.41	5.41	5.41	41.19
	4.5	5.31	5.67	5.67	11.86	3.69	3.69	3.69	14.61	5.17	5.17	5.17	17.22	7.32	7.32	7.33	21.18	4.71	4.71	4.71	28.93
	5.0	4.18	4.59	4.59	8.64	3.21	3.21	3.21	10.65	4.46	4.46	4.46	12.56	6.20	6.20	6.20	15.44	4.14	4.14	4.14	21.09
	5.5	3.36	3.80	3.80	6.49	2.82	2.82	2.82	8.00	3.88	3.88	3.88	9.43	5.29	5.29	5.29	11.60	3.67	3.67	3.67	15.85
	6.0	2.75	3.19	3.19	5.00	2.49	2.49	2.49	6.17	3.41	3.41	3.41	7.27	4.44	4.44	4.44	8.93	3.28	3.28	3.28	12.21
	6.5	2.29	2.72	2.72	3.93	2.22	2.22	2.22	4.85	3.01	3.01	3.01	5.71	3.79	3.79	3.79	7.03	2.94	2.94	2.94	9.60
	7.0	1.93	2.34	2.34	3.15	1.99	1.99	1.99	3.88	2.68	2.68	2.68	4.58	3.27	3.27	3.27	5.63	2.66	2.66	2.66	7.69
CONTINUOUS END	4.0	7.68	8.31	8.31	13.28	4.53	4.53	4.53	16.37	6.47	6.47	6.47	19.29	9.55	9.55	9.55	23.72	5.68	5.68	5.68	32.41
	4.5	5.84	6.62	6.62	9.33	3.92	3.91	3.92	11.50	5.56	5.54	5.56	13.55	8.05	8.03	8.05	16.66	4.96	4.95	4.96	22.76
	5.0	4.56	5.36	5.36	6.80	3.43	3.43	3.43	8.38	4.82	4.82	4.82	9.88	6.86	6.86	6.86	12.15	4.38	4.38	4.38	16.59
	5.5	3.64	4.43	4.43	5.11	3.03	3.03	3.03	6.30	4.22	4.22	4.22	7.42	5.91	5.90	5.91	9.13	3.90	3.89	3.90	12.47
	6.0	2.96	3.72	3.72	3.94	2.70	2.70	2.70	4.85	3.73	3.73	3.73	5.72	5.14	5.14	5.14	7.03	3.50	3.50	3.50	9.60
	6.5	2.45	3.17	3.17	3.10	2.41	2.41	2.41	3.82	3.31	3.31	3.31	4.50	4.42	4.42	4.42	5.53	3.16	3.15	3.16	7.55
	7.0	2.05	2.73	2.73	2.48	2.17	2.17	2.17	3.06	2.96	2.96	2.96	3.60	3.81	3.81	3.81	4.43	2.86	2.86	2.86	6.05
CONTINUOUS INTERNAL	4.0	9.48	10.15	10.15	28.95	5.44	5.44	5.44	35.68	7.79	7.79	7.79	42.05	11.57	11.57	11.57	51.71	6.80	6.80	6.80	70.65
	4.5	7.20	8.19	8.19	20.33	4.72	4.72	4.72	25.06	6.70	6.70	6.70	29.53	9.76	9.76	9.76	36.32	5.94	5.94	5.94	49.62
	5.0	5.62	6.64	6.64	14.82	4.14	4.14	4.14	18.27	5.82	5.82	5.82	21.53	8.34	8.34	8.34	26.48	5.25	5.25	5.25	36.17
	5.5	4.49	5.48	5.48	11.14	3.66	3.66	3.66	13.73	5.11	5.11	5.11	16.18	7.20	7.20	7.20	19.89	4.68	4.68	4.68	27.18
	6.0	3.65	4.61	4.61	8.58	3.26	3.26	3.26	10.57	4.52	4.52	4.52	12.46	6.27	6.27	6.27	15.32	4.21	4.21	4.21	20.93
	6.5	3.01	3.93	3.93	6.75	2.92	2.92	2.92	8.32	4.02	4.02	4.02	9.80	5.47	5.47	5.47	12.05	3.80	3.80	3.80	16.46
	7.0	2.51	3.39	3.39	5.40	2.63	2.63	2.63	6.66	3.60	3.60	3.60	7.85	4.72	4.72	4.72	9.65	3.45	3.45	3.45	13.18
LAPPED 10% END	4.0	8.97	10.84	10.84	14.13	5.29	5.30	5.30	17.42	7.68	7.68	7.68	20.52	11.76	11.76	11.76	25.24	6.54	6.54	6.54	34.48
	4.5	6.60	8.61	8.61	9.87	4.53	4.53	4.53	12.17	6.52	6.51	6.51	14.34	9.78	9.78	9.77	17.63	5.64	5.64	5.64	24.09
	5.0	5.03	6.77	6.77	7.16	3.94	3.94	3.94	8.83	5.62	5.62	5.62	10.40	8.26	8.26	8.26	12.79	4.95	4.95	4.95	17.48
	5.5	3.95	5.47	5.47	5.36	3.46	3.45	3.46	6.61	4.89	4.88	4.89	7.79	7.05	7.05	7.05	9.57	4.38	4.37	4.38	13.08
	6.0	3.15	4.51	4.51	4.12	3.06	3.06	3.06	5.07	4.29	4.29	4.28	5.98	6.08	6.08	6.07	7.35	3.91	3.91	3.90	10.04
	6.5	2.57	3.84	3.84	3.24	2.76	2.75	2.75	3.99	3.84	3.83	3.83	4.70	5.35	5.35	5.35	5.78	3.54	3.54	3.54	7.90
	7.0	2.13	3.31	3.31	2.59	2.49	2.49	2.49	3.19	3.45	3.45	3.45	3.76	4.62	4.62	4.62	4.63	3.23	3.23	3.23	6.32
LAPPED 20% END	4.0	8.97	11.71	11.71	14.31	5.57	5.57	5.57	17.64	8.11	8.12	8.11	20.79	12.59	12.60	12.59	25.57	6.85	6.85	6.85	34.93
	4.5	6.61	9.26	9.26	10.05	4.88	4.87	4.87	12.39	7.06	7.06	7.06	14.60	10.80	10.80	10.80	17.95	6.03	6.03	6.02	24.52
	5.0	5.04	7.48	7.48	7.32	4.31	4.31	4.31	9.03	6.21	6.21	6.21	10.64	9.36	9.36	9.36	13.08	5.36	5.36	5.36	17.87
	5.5	3.95	6.17	6.17	5.50	3.85	3.85	3.85	6.78	5.52	5.51	5.52	7.99	8.19	8.19	8.19	9.82	4.82	4.81	4.82	13.42
	6.0	3.16	5.18	5.18	4.24	3.46	3.46	3.47	5.22	4.93	4.93	4.93	6.15	7.20	7.20	7.20	7.56	4.35	4.35	4.36	10.34
	6.5	2.57	4.40	4.41	3.33	3.14	3.13	3.14	4.11	4.44	4.44	4.44	4.84	6.15	6.15	6.15	5.95	3.97	3.96	3.97	8.13
	7.0	2.13	3.63	3.81	2.67	2.86	2.86	2.85	3.29	4.02	4.02	4.02	3.87	5.30	5.30	5.30	4.76	3.64	3.64	3.63	6.51
LAPPED 10% INTERNAL	4.0	12.26	13.65	13.65	32.62	6.58	6.58	6.58	40.21	9.56	9.56	9.56	47.38	14.70	14.70	14.70	58.26	8.11	8.11	8.11	79.60
	4.5	8.88	10.96	10.96	22.47	5.61	5.61	5.61	27.70	8.10	8.10	8.10	32.64	12.19	12.19	12.19	40.14	6.98	6.98	6.98	54.84
	5.0	6.70	8.98	8.98	16.06	4.88	4.88	4.88	19.79	6.96	6.96	6.96	23.32	10.31	10.31	10.31	28.68	6.11	6.11	6.11	39.18
	5.5	5.25	7.27	7.27	11.94	4.27	4.27	4.27	14.72	6.05	6.05	6.05	17.34	8.78	8.78	8.78	21.33	5.39	5.39	5.39	29.14
	6.0	4.15	5.95	5.95	9.07	3.78	3.77	3.77	11.19	5.31	5.31	5.31	13.18	7.57	7.56	7.56	16.21	4.81	4.81	4.81	22.14
	6.5	3.41	5.07	5.07	7.14	3.40	3.40	3.40	8.80	4.75	4.75	4.75	10.37	6.68	6.67	6.67	12.75	4.36	4.36	4.36	17.42
	7.0	2.81	4.36	4.38	5.71	3.08	3.09	3.09	7.04	4.28	4.28	4.28	8.30	5.94	5.95	5.95	10.21	3.98	3.98	3.98	13.94

ULTIMATE UNIFORMLY DISTRIBUTED LOAD: 7.5 – 10.5 M

		HST 200/12				HST 200/15				HST 200/18				HST 250/13				HST 250/15			
		$\phi_b w_{bx}$		w_s		$\phi_b w_{bx}$		w_s		$\phi_b w_{bx}$		w_s		$\phi_b w_{bx}$		w_s		$\phi_b w_{bx}$		w_s	
		(kN/m)				(kN/m)				(kN/m)				(kN/m)				(kN/m)			
SPAN	(M)	1B	2B	3B	DEF	1B	2B	3B	DEF	1B	2B	3B	DEF	1B	2B	3B	DEF	1B	2B	3B	DEF
SINGLE SPAN	7.5	0.96	1.24	1.24	0.68	1.29	1.70	1.70	0.87	1.58	2.04	2.04	1.07	1.77	1.92	1.92	1.31	2.16	2.35	2.35	1.55
	8.0	0.76	1.09	1.09	0.56	1.01	1.49	1.49	0.72	1.27	1.79	1.79	0.88	1.46	1.69	1.69	1.08	1.78	2.07	2.07	1.28
	8.5	0.61	0.96	0.96	0.46	0.81	1.31	1.32	0.60	1.00	1.55	1.59	0.73	1.20	1.49	1.49	0.90	1.45	1.83	1.83	1.06
	9.0	0.50	0.82	0.86	0.39	0.66	1.12	1.18	0.50	0.80	1.34	1.42	0.62	0.98	1.33	1.33	0.76	1.18	1.63	1.63	0.90
	9.5	0.41	0.70	0.77	0.33	0.54	0.96	1.06	0.43	0.65	1.15	1.27	0.52	0.81	1.20	1.20	0.65	0.96	1.47	1.47	0.76
	10.0	0.34	0.61	0.70	0.29	0.44	0.83	0.96	0.37	0.53	0.99	1.15	0.45	0.67	1.08	1.08	0.55	0.80	1.32	1.32	0.65
	10.5	0.28	0.52	0.63	0.25	0.37	0.71	0.87	0.32	0.44	0.86	1.04	0.39	0.56	0.94	0.98	0.48	0.66	1.15	1.20	0.56
DOUBLE SPAN	7.5	1.24	1.24	1.24	1.62	1.70	1.70	2.09	2.04	2.04	2.04	2.56	1.79	1.79	1.79	3.16	2.35	2.35	2.35	3.72	
	8.0	1.09	1.09	1.09	1.34	1.49	1.49	1.72	1.79	1.79	1.79	2.11	1.62	1.62	1.62	2.60	2.07	2.07	2.07	3.07	
	8.5	0.96	0.96	0.96	1.12	1.32	1.32	1.43	1.59	1.59	1.59	1.76	1.47	1.47	1.47	2.17	1.83	1.83	1.83	2.56	
	9.0	0.85	0.86	0.86	0.94	1.16	1.18	1.21	1.38	1.42	1.42	1.48	1.33	1.33	1.33	1.83	1.63	1.63	1.63	2.15	
	9.5	0.73	0.77	0.77	0.80	1.00	1.06	1.06	1.03	1.20	1.27	1.27	1.26	1.20	1.20	1.20	1.55	1.47	1.47	1.47	1.83
	10.0	0.64	0.70	0.70	0.68	0.87	0.96	0.96	0.88	1.04	1.15	1.15	1.08	1.08	1.08	1.08	1.33	1.32	1.32	1.32	1.57
	10.5	0.55	0.63	0.63	0.59	0.75	0.87	0.87	0.76	0.91	1.04	1.04	0.93	0.98	0.98	0.98	1.15	1.19	1.20	1.20	1.36
CONTINUOUS END	7.5	1.44	1.44	1.44	1.28	1.98	1.98	1.98	1.64	2.38	2.38	2.38	2.02	1.97	1.96	1.97	2.48	2.66	2.66	2.66	2.93
	8.0	1.24	1.27	1.27	1.05	1.70	1.74	1.74	1.35	2.03	2.09	2.09	1.66	1.79	1.79	1.78	2.05	2.40	2.40	2.40	2.41
	8.5	1.05	1.12	1.12	0.88	1.44	1.54	1.54	1.13	1.72	1.85	1.85	1.38	1.63	1.63	1.63	1.71	2.14	2.14	2.14	2.01
	9.0	0.89	1.00	1.00	0.74	1.22	1.38	1.38	0.95	1.47	1.65	1.65	1.17	1.49	1.49	1.49	1.44	1.91	1.91	1.91	1.69
	9.5	0.76	0.90	0.90	0.63	1.02	1.24	1.24	0.81	1.25	1.48	1.48	0.99	1.36	1.37	1.37	1.22	1.66	1.71	1.71	1.44
	10.0	0.64	0.81	0.81	0.54	0.85	1.12	1.12	0.69	1.06	1.34	1.34	0.85	1.18	1.26	1.26	1.05	1.44	1.54	1.54	1.24
	10.5	0.53	0.74	0.74	0.47	0.71	1.01	1.01	0.60	0.89	1.21	1.22	0.73	1.02	1.14	1.14	0.91	1.25	1.40	1.40	1.07
CONTINUOUS INTERNAL	7.5	1.75	1.75	1.75	2.78	2.46	2.46	2.46	3.58	2.94	2.95	2.95	4.39	2.38	2.38	2.38	5.41	3.24	3.24	3.24	6.38
	8.0	1.52	1.57	1.57	2.29	2.09	2.16	2.16	2.95	2.49	2.59	2.59	3.62	2.17	2.17	2.17	4.46	2.93	2.93	2.93	5.26
	8.5	1.29	1.39	1.39	1.91	1.77	1.91	1.91	2.46	2.11	2.30	2.30	3.02	1.98	1.98	1.98	3.72	2.65	2.65	2.65	4.38
	9.0	1.10	1.24	1.24	1.61	1.49	1.70	1.70	2.07	1.80	2.05	2.05	2.54	1.81	1.81	1.81	3.13	2.36	2.36	2.36	3.69
	9.5	0.93	1.11	1.11	1.37	1.26	1.53	1.53	1.76	1.53	1.84	1.84	2.16	1.67	1.67	1.67	2.66	2.04	2.12	2.12	3.14
	10.0	0.79	1.01	1.01	1.17	1.06	1.38	1.38	1.51	1.31	1.66	1.66	1.85	1.45	1.54	1.54	2.28	1.76	1.91	1.91	2.69
	10.5	0.66	0.91	0.91	1.01	0.89	1.25	1.25	1.30	1.11	1.49	1.50	1.60	1.25	1.41	1.41	1.97	1.53	1.73	1.73	2.33
LAPPED 10% END	7.5	1.70	1.70	1.70	1.34	2.33	2.40	2.40	1.72	2.78	2.89	2.89	2.11	2.27	2.27	2.27	2.60	3.12	3.12	3.12	3.06
	8.0	1.43	1.54	1.54	1.10	1.95	2.11	2.11	1.41	2.34	2.54	2.54	1.74	2.07	2.07	2.07	2.14	2.83	2.83	2.83	2.52
	8.5	1.20	1.36	1.36	0.92	1.63	1.87	1.87	1.18	1.97	2.25	2.25	1.45	1.90	1.90	1.90	1.78	2.58	2.58	2.58	2.10
	9.0	1.00	1.22	1.22	0.77	1.34	1.67	1.67	0.99	1.65	2.00	2.00	1.22	1.74	1.74	1.74	1.50	2.21	2.31	2.31	1.77
	9.5	0.82	1.09	1.09	0.66	1.10	1.50	1.50	0.85	1.37	1.80	1.80	1.04	1.56	1.61	1.61	1.28	1.90	2.07	2.07	1.51
	10.0	0.68	0.97	0.98	0.56	0.91	1.33	1.35	0.72	1.12	1.58	1.62	0.89	1.33	1.49	1.49	1.10	1.61	1.87	1.87	1.29
	10.5	0.57	0.85	0.89	0.49	0.76	1.17	1.23	0.63	0.93	1.40	1.47	0.77	1.13	1.38	1.38	0.95	1.35	1.70	1.70	1.12
LAPPED 20% END	7.5	1.84	2.01	2.01	1.37	2.52	2.76	2.76	1.77	3.01	3.32	3.32	2.17	2.62	2.62	2.61	2.67	3.66	3.66	3.65	3.15
	8.0	1.52	1.77	1.77	1.13	2.07	2.43	2.43	1.46	2.50	2.91	2.91	1.79	2.40	2.40	2.40	2.20	3.29	3.34	3.34	2.60
	8.5	1.26	1.56	1.56	0.94	1.70	2.15	2.15	1.21	2.08	2.58	2.58	1.49	2.21	2.21	2.21	1.84	2.80	2.97	2.97	2.16
	9.0	1.04	1.39	1.40	0.79	1.39	1.91	1.92	1.02	1.72	2.28	2.30	1.25	1.94	2.05	2.05	1.55	2.37	2.65	2.65	1.82
	9.5	0.85	1.21	1.25	0.68	1.14	1.66	1.72	0.87	1.42	1.98	2.07	1.07	1.65	1.90	1.90	1.32	2.00	2.38	2.38	1.55
	10.0	0.71	1.05	1.13	0.58	0.94	1.44	1.55	0.75	1.16	1.72	1.87	0.91	1.39	1.75	1.75	1.13	1.68	2.15	2.15	1.33
	10.5	0.59	0.92	1.03	0.50	0.79	1.25	1.41	0.64	0.96	1.50	1.69	0.79	1.17	1.59	1.59	0.97	1.40	1.95	1.95	1.15
LAPPED 10% INTERNAL	7.5	2.12	2.12	2.12	2.94	3.05	3.17	3.17	3.79	3.64	3.81	3.81	4.65	2.81	2.81	2.81	5.73	3.87	3.87	3.87	6.75
	8.0	1.86	1.92	1.92	2.42	2.55	2.79	2.79	3.12	3.05	3.35	3.35	3.83	2.57	2.57	2.57	4.72	3.52	3.52	3.52	5.56
	8.5	1.56	1.74	1.74	2.02	2.13	2.47	2.47	2.60	2.56	2.97	2.97	3.19	2.35	2.35	2.35	3.93	3.21	3.21	3.21	4.64
	9.0	1.31	1.59	1.59	1.70	1.77	2.20	2.20	2.19	2.16	2.65	2.65	2.69	2.16	2.17	2.17	3.32	2.89	2.94	2.94	3.91
	9.5	1.09	1.44	1.44	1.45	1.47	1.98	1.98	1.86	1.81	2.38	2.38	2.29	2.00	2.00	2.00	2.82	2.47	2.70	2.68	3.32
	10.0	0.91	1.27	1.30	1.24	1.22	1.75	1.79	1.60	1.52	2.08	2.14	1.96	1.74	1.85	1.85	2.42	2.12	2.47	2.47	2.85
	10.5	0.77	1.12	1.18	1.07	1.02	1.53	1.62	1.38	1.26	1.82	1.95	1.69	1.49	1.72	1.72	2.09	1.80	2.24	2.24	2.46

ULTIMATE UNIFORMLY DISTRIBUTED LOAD: 7.5 – 10.5 M

SPAN		HST 250/18				HST 300/15				HST 300/18				HST 350/18				HST 400/20			
		$\phi_b w_{bx}$			w_s	$\phi_b w_{bx}$			w_s	$\phi_b w_{bx}$			w_s	$\phi_b w_{bx}$			w_s	$\phi_b w_{bx}$			w_s
		(kN/m)				(kN/m)				(kN/m)				(kN/m)				(kN/m)			
		(M)	1B	2B	3B	DEF	1B	2B	3B	DEF	1B	2B	3B	DEF	1B	2B	3B	DEF	1B	2B	3B
SINGLE SPAN	7.5	2.60	2.84	2.84	1.90	2.87	2.87	2.87	2.60	3.72	3.72	3.72	3.19	4.50	4.50	4.50	4.63	6.13	6.13	6.13	7.25
	8.0	2.15	2.50	2.50	1.57	2.53	2.53	2.53	2.14	3.27	3.27	3.27	2.63	3.96	3.96	3.96	3.81	5.39	5.39	5.39	5.97
	8.5	1.78	2.21	2.22	1.31	2.23	2.24	2.24	1.79	2.81	2.90	2.90	2.19	3.51	3.51	3.51	3.18	4.77	4.77	4.77	4.98
	9.0	1.47	1.98	1.98	1.10	1.90	2.00	2.00	1.50	2.38	2.58	2.58	1.85	3.03	3.13	3.13	2.68	4.25	4.26	4.26	4.19
	9.5	1.21	1.77	1.77	0.94	1.61	1.79	1.79	1.28	2.02	2.32	2.32	1.57	2.59	2.81	2.81	2.28	3.62	3.82	3.82	3.57
	10.0	1.00	1.58	1.60	0.80	1.37	1.62	1.62	1.10	1.72	2.09	2.09	1.35	2.20	2.53	2.53	1.95	3.08	3.45	3.45	3.06
	10.5	0.83	1.38	1.45	0.69	1.16	1.47	1.47	0.95	1.45	1.90	1.90	1.16	1.86	2.30	2.30	1.69	2.62	3.13	3.13	2.64
DOUBLE SPAN	7.5	2.84	2.84	2.84	4.57	2.42	2.42	2.42	6.25	3.57	3.57	3.57	7.67	3.54	3.54	3.54	11.13	4.36	4.36	4.36	17.42
	8.0	2.50	2.50	2.50	3.77	2.20	2.20	2.20	5.15	3.23	3.23	3.23	6.32	3.24	3.24	3.24	9.17	4.01	4.01	4.01	14.36
	8.5	2.22	2.22	2.22	3.14	2.01	2.01	2.01	4.29	2.90	2.90	2.90	5.27	2.98	2.98	2.98	7.64	3.70	3.70	3.70	11.97
	9.0	1.98	1.98	1.98	2.65	1.85	1.85	1.85	3.62	2.58	2.58	2.58	4.44	2.74	2.75	2.74	6.44	3.43	3.43	3.43	10.08
	9.5	1.77	1.77	1.77	2.25	1.70	1.70	1.70	3.08	2.32	2.32	2.32	3.78	2.54	2.54	2.54	5.48	3.19	3.19	3.19	8.57
	10.0	1.60	1.60	1.60	1.93	1.57	1.57	1.57	2.64	2.09	2.09	2.09	3.24	2.35	2.35	2.35	4.69	2.97	2.97	2.97	7.35
	10.5	1.43	1.45	1.45	1.67	1.46	1.46	1.46	2.28	1.90	1.90	1.90	2.80	2.18	2.18	2.18	4.06	2.77	2.77	2.77	6.35
CONTINUOUS END	7.5	3.32	3.32	3.32	3.60	2.61	2.61	2.61	4.92	3.92	3.92	3.92	6.04	3.80	3.80	3.80	8.76	4.63	4.62	4.63	13.71
	8.0	2.92	2.92	2.92	2.97	2.39	2.39	2.39	4.05	3.56	3.56	3.56	4.97	3.49	3.49	3.49	7.21	4.27	4.27	4.27	11.30
	8.5	2.58	2.58	2.58	2.47	2.19	2.19	2.19	3.38	3.24	3.24	3.24	4.15	3.22	3.22	3.22	6.02	3.96	3.95	3.96	9.42
	9.0	2.30	2.30	2.30	2.08	2.02	2.02	2.02	2.85	2.97	2.97	2.97	3.49	2.98	2.98	2.98	5.07	3.68	3.68	3.68	7.93
	9.5	1.99	2.07	2.07	1.77	1.87	1.87	1.87	2.42	2.70	2.70	2.70	2.97	2.76	2.76	2.76	4.31	3.43	3.42	3.43	6.75
	10.0	1.73	1.87	1.87	1.52	1.73	1.73	1.73	2.07	2.44	2.44	2.44	2.55	2.57	2.57	2.57	3.69	3.20	3.20	3.20	5.78
	10.5	1.51	1.69	1.69	1.31	1.61	1.61	1.61	1.79	2.21	2.21	2.21	2.20	2.39	2.39	2.39	3.19	2.99	2.99	3.00	5.00
CONTINUOUS INTERNAL	7.5	4.11	4.11	4.11	7.84	3.15	3.15	3.15	10.72	4.75	4.75	4.75	13.16	4.58	4.58	4.58	19.08	5.56	5.56	5.56	29.88
	8.0	3.61	3.61	3.61	6.46	2.89	2.89	2.89	8.83	4.32	4.32	4.32	10.84	4.21	4.21	4.21	15.72	5.14	5.14	5.14	24.62
	8.5	3.20	3.20	3.20	5.39	2.65	2.65	2.65	7.36	3.94	3.94	3.94	9.04	3.89	3.89	3.89	13.11	4.76	4.76	4.76	20.53
	9.0	2.83	2.85	2.85	4.54	2.45	2.45	2.45	6.20	3.61	3.61	3.61	7.61	3.60	3.60	3.60	11.04	4.43	4.43	4.43	17.29
	9.5	2.45	2.56	2.56	3.86	2.27	2.27	2.27	5.27	3.32	3.32	3.32	6.47	3.34	3.34	3.34	9.39	4.13	4.13	4.13	14.70
	10.0	2.12	2.31	2.31	3.31	2.10	2.10	2.10	4.52	3.02	3.02	3.02	5.55	3.11	3.11	3.11	8.05	3.86	3.86	3.86	12.61
	10.5	1.84	2.10	2.10	2.86	1.95	1.95	1.95	3.91	2.74	2.74	2.74	4.80	2.90	2.90	2.90	6.95	3.62	3.62	3.62	10.89
LAPPED 10% END	7.5	4.02	4.02	4.02	3.76	2.96	2.96	2.96	5.14	4.53	4.53	4.53	6.31	4.27	4.27	4.27	9.15	5.14	5.14	5.14	14.33
	8.0	3.53	3.53	3.53	3.10	2.72	2.72	2.72	4.24	4.13	4.13	4.13	5.20	3.94	3.94	3.94	7.54	4.76	4.76	4.76	11.81
	8.5	3.09	3.13	3.13	2.59	2.51	2.51	2.51	3.53	3.78	3.78	3.78	4.34	3.65	3.65	3.65	6.29	4.43	4.43	4.43	9.85
	9.0	2.66	2.79	2.79	2.18	2.32	2.32	2.32	2.98	3.48	3.48	3.48	3.65	3.39	3.39	3.39	5.30	4.13	4.13	4.13	8.30
	9.5	2.29	2.51	2.51	1.85	2.16	2.15	2.15	2.53	3.21	3.20	3.20	3.11	3.15	3.15	3.15	4.50	3.86	3.86	3.86	7.05
	10.0	1.97	2.26	2.26	1.59	2.01	2.01	2.00	2.17	2.96	2.96	2.96	2.66	2.94	2.94	2.94	3.86	3.62	3.62	3.62	6.05
	10.5	1.68	2.05	2.05	1.37	1.87	1.87	1.87	1.87	2.64	2.68	2.68	2.30	2.75	2.75	2.75	3.34	3.40	3.40	3.40	5.22
LAPPED 20% END	7.5	4.62	4.62	4.62	3.87	3.35	3.35	3.34	5.29	5.23	5.23	5.22	6.50	4.79	4.79	4.79	9.42	5.71	5.71	5.70	14.75
	8.0	3.95	4.06	4.06	3.19	3.09	3.09	3.09	4.36	4.80	4.80	4.80	5.35	4.44	4.44	4.44	7.76	5.30	5.30	5.30	12.16
	8.5	3.36	3.60	3.60	2.66	2.87	2.87	2.87	3.63	4.42	4.42	4.42	4.46	4.13	4.13	4.13	6.47	4.94	4.95	4.94	10.13
	9.0	2.85	3.21	3.21	2.24	2.67	2.67	2.67	3.06	4.09	4.09	4.09	3.76	3.85	3.85	3.85	5.45	4.63	4.63	4.63	8.54
	9.5	2.43	2.88	2.88	1.91	2.49	2.49	2.49	2.60	3.74	3.76	3.76	3.20	3.60	3.60	3.60	4.64	4.34	4.34	4.34	7.26
	10.0	2.06	2.60	2.60	1.63	2.32	2.32	2.32	2.23	3.26	3.40	3.40	2.74	3.37	3.37	3.37	3.97	4.08	4.08	4.08	6.22
	10.5	1.75	2.35	2.36	1.41	2.18	2.18	2.18	1.93	2.84	3.08	3.08	2.37	3.17	3.16	3.17	3.43	3.85	3.85	3.85	5.38
LAPPED 10% INTERNAL	7.5	5.30	5.30	5.30	8.30	3.65	3.65	3.65	11.34	5.61	5.61	5.61	13.92	5.27	5.27	5.27	20.19	6.32	6.32	6.32	31.61
	8.0	4.67	4.67	4.67	6.84	3.36	3.36	3.36	9.34	5.12	5.12	5.13	11.47	4.86	4.86	4.86	16.63	5.86	5.86	5.86	26.05
	8.5	4.05	4.13	4.13	5.70	3.10	3.10	3.10	7.79	4.70	4.70	4.70	9.56	4.50	4.50	4.50	13.87	5.45	5.45	5.45	21.72
	9.0	3.47	3.69	3.69	4.80	2.87	2.87	2.87	6.56	4.32	4.32	4.32	8.05	4.18	4.18	4.18	11.68	5.08	5.08	5.08	18.29
	9.5	2.98	3.31	3.31	4.08	2.67	2.67	2.67	5.58	3.99	3.99	3.99	6.85	3.90	3.90	3.90	9.93	4.76	4.75	4.75	15.55
	10.0	2.56	2.99	2.99	3.50	2.48	2.48	2.48	4.78	3.69	3.69	3.69	5.87	3.64	3.64	3.64	8.52	4.46	4.46	4.46	13.34
	10.5	2.20	2.71	2.71	3.02	2.32	2.32	2.32	4.13	3.42	3.42	3.42	5.07	3.41	3.41	3.41	7.36	4.19	4.19	4.19	11.52

ULTIMATE UNIFORMLY DISTRIBUTED LOAD: 11.0 – 14.0 M

		HST 300/15				HST 300/18				HST 300/24				HST 300/30				HST 350/18			
		$\phi_b w_{bx}$		w_s		$\phi_b w_{bx}$		w_s		$\phi_b w_{bx}$		w_s		$\phi_b w_{bx}$		w_s		$\phi_b w_{bx}$		w_s	
		(kN/m)				(kN/m)				(kN/m)				(kN/m)				(kN/m)			
SPAN	(M)	1B	2B	3B	DEF	1B	2B	3B	DEF	1B	2B	3B	DEF	1B	2B	3B	DEF	1B	2B	3B	DEF
SINGLE SPAN	11.0	0.98	1.34	1.34	0.82	1.22	1.73	1.73	1.01	1.76	2.64	2.64	1.40	2.17	3.41	3.53	1.75	1.57	2.09	2.09	1.47
	11.5	0.83	1.22	1.22	0.72	1.04	1.58	1.58	0.89	1.48	2.37	2.42	1.23	1.82	3.03	3.23	1.53	1.33	1.92	1.92	1.28
	12.0	0.71	1.12	1.12	0.64	0.88	1.45	1.45	0.78	1.25	2.12	2.22	1.08	1.55	2.69	2.97	1.35	1.14	1.76	1.76	1.13
	12.5	0.61	1.03	1.03	0.56	0.76	1.30	1.34	0.69	1.06	1.89	2.05	0.96	1.32	2.40	2.74	1.19	0.97	1.62	1.62	1.00
	13.0	0.52	0.92	0.96	0.50	0.66	1.16	1.24	0.61	0.91	1.69	1.89	0.85	1.14	2.13	2.53	1.06	0.84	1.47	1.50	0.89
	13.5	0.46	0.83	0.89	0.45	0.57	1.04	1.15	0.55	0.79	1.51	1.75	0.76	0.98	1.90	2.35	0.95	0.73	1.32	1.39	0.79
14.0	0.40	0.74	0.83	0.40	0.50	0.93	1.07	0.49	0.68	1.35	1.63	0.68	0.85	1.69	2.18	0.85	0.64	1.19	1.29	0.71	
DOUBLE SPAN	11.0	1.34	1.34	1.34	1.98	1.73	1.73	1.73	2.43	2.64	2.64	2.64	3.37	3.51	3.53	3.53	4.21	2.03	2.03	2.03	3.53
	11.5	1.22	1.22	1.22	1.73	1.58	1.58	1.58	2.13	2.42	2.42	2.42	2.95	3.12	3.23	3.23	3.69	1.90	1.90	1.90	3.09
	12.0	1.12	1.12	1.12	1.53	1.45	1.45	1.45	1.87	2.18	2.22	2.22	2.60	2.79	2.97	2.97	3.24	1.76	1.76	1.76	2.72
	12.5	1.03	1.03	1.03	1.35	1.34	1.34	1.34	1.66	1.96	2.05	2.05	2.30	2.50	2.74	2.74	2.87	1.62	1.62	1.62	2.40
	13.0	0.96	0.96	0.96	1.20	1.21	1.24	1.24	1.47	1.76	1.89	1.89	2.04	2.24	2.53	2.53	2.55	1.50	1.50	1.50	2.14
	13.5	0.86	0.89	0.89	1.07	1.09	1.15	1.15	1.32	1.58	1.75	1.75	1.82	2.01	2.35	2.35	2.28	1.37	1.39	1.39	1.91
14.0	0.78	0.83	0.83	0.96	0.98	1.07	1.07	1.18	1.43	1.63	1.63	1.64	1.80	2.18	2.18	2.04	1.24	1.29	1.29	1.71	
CONTINUOUS END	11.0	1.50	1.50	1.50	1.56	2.02	2.02	2.02	1.91	2.95	3.08	3.08	2.65	3.75	4.12	4.12	3.31	2.23	2.23	2.23	2.78
	11.5	1.40	1.40	1.40	1.36	1.79	1.85	1.85	1.67	2.61	2.82	2.82	2.32	3.31	3.77	3.77	2.90	2.09	2.09	2.09	2.43
	12.0	1.26	1.31	1.31	1.20	1.59	1.70	1.70	1.47	2.31	2.59	2.59	2.04	2.92	3.46	3.46	2.55	1.96	1.96	1.96	2.14
	12.5	1.12	1.21	1.21	1.06	1.41	1.56	1.56	1.30	2.05	2.39	2.39	1.81	2.57	3.19	3.19	2.26	1.79	1.84	1.84	1.89
	13.0	0.99	1.12	1.12	0.94	1.24	1.44	1.44	1.16	1.81	2.21	2.21	1.61	2.24	2.95	2.95	2.01	1.59	1.73	1.73	1.68
	13.5	0.87	1.04	1.04	0.84	1.09	1.34	1.34	1.04	1.58	2.05	2.05	1.44	1.96	2.69	2.74	1.79	1.40	1.62	1.62	1.50
14.0	0.76	0.96	0.96	0.76	0.96	1.25	1.25	0.93	1.38	1.90	1.90	1.29	1.70	2.45	2.55	1.61	1.23	1.51	1.51	1.35	
CONTINUOUS INTERNAL	11.0	1.82	1.82	1.82	3.40	2.48	2.50	2.50	4.17	3.62	3.81	3.81	5.78	4.60	5.11	5.11	7.22	2.71	2.71	2.71	6.05
	11.5	1.70	1.70	1.70	2.97	2.20	2.28	2.28	3.65	3.20	3.49	3.49	5.06	4.05	4.67	4.67	6.32	2.54	2.54	2.54	5.29
	12.0	1.55	1.59	1.59	2.62	1.94	2.10	2.10	3.21	2.83	3.21	3.21	4.45	3.57	4.29	4.29	5.56	2.38	2.38	2.38	4.66
	12.5	1.37	1.49	1.49	2.32	1.72	1.93	1.93	2.84	2.51	2.95	2.95	3.94	3.15	3.95	3.95	4.92	2.20	2.24	2.24	4.12
	13.0	1.22	1.38	1.38	2.06	1.52	1.79	1.79	2.53	2.22	2.73	2.73	3.50	2.78	3.65	3.66	4.37	1.95	2.11	2.11	3.66
	13.5	1.08	1.28	1.28	1.84	1.35	1.66	1.66	2.26	1.96	2.53	2.53	3.13	2.44	3.31	3.39	3.91	1.73	1.99	1.99	3.27
14.0	0.95	1.19	1.19	1.65	1.19	1.54	1.54	2.02	1.73	2.36	2.36	2.80	2.15	3.01	3.15	3.50	1.53	1.87	1.87	2.93	
LAPPED 10% END	11.0	1.75	1.75	1.75	1.63	2.32	2.44	2.44	2.00	3.38	3.73	3.73	2.77	4.27	5.00	5.00	3.46	2.58	2.58	2.58	2.90
	11.5	1.63	1.64	1.64	1.43	2.04	2.24	2.24	1.75	2.97	3.42	3.42	2.43	3.71	4.57	4.57	3.03	2.42	2.42	2.42	2.54
	12.0	1.42	1.54	1.54	1.26	1.78	2.05	2.05	1.54	2.58	3.14	3.14	2.14	3.20	4.20	4.20	2.67	2.28	2.28	2.28	2.24
	12.5	1.24	1.44	1.44	1.11	1.55	1.89	1.89	1.36	2.24	2.89	2.89	1.89	2.76	3.81	3.87	2.36	1.99	2.15	2.15	1.98
	13.0	1.07	1.35	1.35	0.99	1.34	1.75	1.75	1.21	1.92	2.67	2.67	1.68	2.37	3.43	3.58	2.10	1.72	2.03	2.03	1.76
	13.5	0.93	1.25	1.25	0.88	1.16	1.62	1.62	1.08	1.66	2.43	2.48	1.50	2.05	3.10	3.32	1.87	1.50	1.91	1.91	1.57
14.0	0.81	1.17	1.17	0.79	1.02	1.51	1.51	0.97	1.44	2.21	2.31	1.35	1.78	2.81	3.08	1.68	1.31	1.81	1.81	1.41	
LAPPED 20% END	11.0	1.96	2.04	2.04	1.68	2.47	2.81	2.81	2.06	3.58	4.29	4.29	2.85	4.48	5.74	5.74	3.56	2.98	2.98	2.98	2.99
	11.5	1.71	1.92	1.92	1.47	2.14	2.57	2.57	1.80	3.11	3.92	3.92	2.50	3.86	5.16	5.25	3.12	2.73	2.81	2.81	2.61
	12.0	1.48	1.81	1.81	1.29	1.86	2.36	2.36	1.59	2.69	3.60	3.60	2.20	3.32	4.62	4.82	2.75	2.38	2.65	2.65	2.30
	12.5	1.28	1.68	1.68	1.14	1.60	2.17	2.17	1.40	2.31	3.24	3.32	1.95	2.85	4.14	4.44	2.43	2.06	2.51	2.51	2.03
	13.0	1.11	1.55	1.55	1.02	1.39	2.00	2.01	1.25	1.98	2.92	3.07	1.73	2.45	3.71	4.11	2.16	1.78	2.38	2.38	1.81
	13.5	0.96	1.43	1.44	0.91	1.21	1.80	1.86	1.11	1.71	2.63	2.85	1.54	2.12	3.33	3.81	1.93	1.55	2.25	2.25	1.62
14.0	0.84	1.29	1.34	0.81	1.05	1.63	1.73	1.00	1.49	2.37	2.65	1.38	1.84	2.99	3.54	1.73	1.35	2.06	2.10	1.45	
LAPPED 10% INTERNAL	11.0	2.17	2.17	2.17	3.59	3.03	3.18	3.18	4.41	4.41	4.93	4.93	6.11	5.56	6.58	6.60	7.64	3.20	3.20	3.20	6.40
	11.5	2.03	2.03	2.03	3.14	2.66	2.95	2.95	3.86	3.86	4.51	4.51	5.35	4.85	6.04	6.04	6.68	3.00	3.00	3.00	5.60
	12.0	1.86	1.91	1.91	2.77	2.33	2.71	2.71	3.40	3.39	4.14	4.14	4.71	4.23	5.54	5.54	5.88	2.83	2.83	2.83	4.93
	12.5	1.63	1.80	1.80	2.45	2.04	2.50	2.50	3.01	2.97	3.82	3.82	4.17	3.69	4.99	5.11	5.20	2.62	2.67	2.67	4.36
	13.0	1.43	1.69	1.69	2.18	1.79	2.31	2.31	2.67	2.59	3.52	3.53	3.70	3.20	4.49	4.72	4.63	2.29	2.52	2.52	3.88
	13.5	1.25	1.60	1.60	1.94	1.56	2.14	2.14	2.39	2.25	3.18	3.27	3.31	2.78	4.06	4.38	4.13	2.00	2.38	2.38	3.46
14.0	1.09	1.51	1.51	1.74	1.36	1.98	1.99	2.14	1.95	2.89	3.04	2.97	2.42	3.67	4.07	3.71	1.75	2.25	2.25	3.10	

ULTIMATE UNIFORMLY DISTRIBUTED LOAD: 11.0 – 14.0 M

SPAN		HST 350/24				HST 350/30				HST 400/20				HST 400/24				HST 400/30			
		$\phi_b w_{bx}$		w_s		$\phi_b w_{bx}$		w_s		$\phi_b w_{bx}$		w_s		$\phi_b w_{bx}$		w_s		$\phi_b w_{bx}$		w_s	
		(kN/m)				(kN/m)				(kN/m)				(kN/m)				(kN/m)			
(M)	1B	2B	3B	DEF	1B	2B	3B	DEF	1B	2B	3B	DEF	1B	2B	3B	DEF	1B	2B	3B	DEF	
SINGLE SPAN	11.0	2.25	3.21	3.21	2.05	2.77	4.32	4.32	2.57	2.22	2.85	2.85	2.30	2.80	3.78	3.78	2.86	3.44	5.09	5.09	3.60
	11.5	1.89	2.94	2.94	1.80	2.33	3.83	3.95	2.25	1.88	2.61	2.61	2.01	2.35	3.46	3.46	2.51	2.89	4.66	4.66	3.15
	12.0	1.60	2.69	2.69	1.58	1.97	3.41	3.63	1.98	1.60	2.39	2.39	1.77	1.98	3.17	3.17	2.20	2.44	4.20	4.28	2.77
	12.5	1.36	2.40	2.49	1.40	1.68	3.04	3.34	1.75	1.37	2.21	2.21	1.57	1.69	2.93	2.93	1.95	2.08	3.75	3.94	2.45
	13.0	1.17	2.15	2.30	1.24	1.44	2.71	3.09	1.56	1.18	2.04	2.04	1.39	1.45	2.65	2.71	1.73	1.79	3.34	3.64	2.18
	13.5	1.01	1.92	2.13	1.11	1.25	2.41	2.87	1.39	1.03	1.86	1.89	1.24	1.25	2.38	2.51	1.55	1.54	2.98	3.38	1.95
	14.0	0.87	1.72	1.98	1.00	1.08	2.15	2.66	1.25	0.89	1.67	1.76	1.11	1.08	2.13	2.33	1.39	1.34	2.66	3.14	1.75
DOUBLE SPAN	11.0	3.21	3.21	3.21	4.94	4.32	4.32	4.32	6.19	2.59	2.59	2.59	5.52	3.78	3.78	3.78	6.88	5.09	5.09	5.09	8.65
	11.5	2.94	2.94	2.94	4.32	3.94	3.95	3.95	5.42	2.43	2.43	2.43	4.83	3.46	3.46	3.46	6.02	4.66	4.66	4.66	7.57
	12.0	2.70	2.70	2.70	3.80	3.52	3.63	3.63	4.77	2.28	2.28	2.28	4.25	3.17	3.17	3.17	5.30	4.28	4.28	4.28	6.66
	12.5	2.48	2.49	2.49	3.36	3.15	3.34	3.34	4.22	2.14	2.14	2.14	3.76	2.93	2.93	2.93	4.69	3.88	3.94	3.94	5.90
	13.0	2.23	2.30	2.30	2.99	2.83	3.09	3.09	3.75	2.02	2.02	2.02	3.35	2.71	2.71	2.71	4.17	3.48	3.64	3.64	5.24
	13.5	2.01	2.13	2.13	2.67	2.54	2.87	2.87	3.35	1.89	1.89	1.89	2.99	2.47	2.51	2.51	3.72	3.12	3.38	3.38	4.68
	14.0	1.81	1.98	1.98	2.39	2.28	2.66	2.66	3.00	1.74	1.76	1.76	2.68	2.23	2.33	2.33	3.34	2.80	3.14	3.14	4.20
CONTINUOUS END	11.0	3.73	3.75	3.75	3.88	4.74	5.04	5.04	4.87	2.81	2.81	2.81	4.35	4.32	4.32	4.33	5.41	5.84	5.94	5.94	6.81
	11.5	3.31	3.43	3.43	3.40	4.19	4.61	4.61	4.26	2.64	2.64	2.64	3.80	4.03	4.03	4.03	4.74	5.16	5.43	5.43	5.96
	12.0	2.93	3.15	3.15	2.99	3.70	4.23	4.23	3.75	2.48	2.48	2.48	3.35	3.62	3.70	3.70	4.17	4.56	4.99	4.99	5.24
	12.5	2.60	2.90	2.90	2.65	3.26	3.90	3.90	3.32	2.34	2.34	2.34	2.96	3.21	3.41	3.41	3.69	4.02	4.60	4.60	4.64
	13.0	2.30	2.68	2.68	2.35	2.85	3.61	3.61	2.95	2.21	2.21	2.21	2.63	2.84	3.16	3.16	3.28	3.52	4.25	4.25	4.12
	13.5	2.02	2.49	2.49	2.10	2.49	3.34	3.34	2.63	1.97	2.09	2.09	2.35	2.50	2.93	2.93	2.93	3.08	3.94	3.94	3.68
	14.0	1.76	2.31	2.31	1.88	2.17	3.10	3.11	2.36	1.73	1.98	1.98	2.11	2.18	2.72	2.72	2.63	2.69	3.67	3.67	3.30
CONTINUOUS INTERNAL	11.0	4.59	4.64	4.64	8.46	5.82	6.23	6.23	10.61	3.40	3.40	3.40	9.47	5.26	5.26	5.26	11.80	7.17	7.35	7.35	14.83
	11.5	4.06	4.24	4.24	7.41	5.13	5.70	5.70	9.29	3.19	3.19	3.19	8.29	4.91	4.91	4.91	10.33	6.32	6.72	6.72	12.98
	12.0	3.59	3.90	3.90	6.52	4.53	5.24	5.24	8.18	3.01	3.01	3.01	7.30	4.44	4.59	4.59	9.09	5.58	6.18	6.18	11.43
	12.5	3.18	3.59	3.59	5.77	3.99	4.83	4.83	7.23	2.84	2.84	2.84	6.46	3.93	4.23	4.23	8.04	4.93	5.69	5.69	10.11
	13.0	2.82	3.32	3.32	5.13	3.52	4.46	4.46	6.43	2.68	2.68	2.68	5.74	3.48	3.91	3.91	7.15	4.35	5.26	5.26	8.99
	13.5	2.50	3.08	3.08	4.58	3.10	4.14	4.14	5.74	2.42	2.54	2.54	5.12	3.09	3.62	3.62	6.38	3.83	4.88	4.88	8.03
	14.0	2.21	2.86	2.87	4.11	2.73	3.81	3.85	5.15	2.15	2.41	2.41	4.59	2.73	3.37	3.37	5.72	3.37	4.54	4.54	7.20
LAPPED 10% END	11.0	4.29	4.54	4.54	4.06	5.41	6.10	6.10	5.09	3.20	3.20	3.20	4.54	5.04	5.04	5.04	5.66	6.67	7.19	7.19	7.12
	11.5	3.77	4.15	4.16	3.55	4.71	5.58	5.58	4.46	3.01	3.01	3.01	3.98	4.65	4.72	4.72	4.95	5.83	6.58	6.58	6.23
	12.0	3.29	3.82	3.82	3.13	4.08	5.13	5.13	3.92	2.85	2.85	2.85	3.50	4.08	4.43	4.43	4.36	5.05	6.04	6.04	5.48
	12.5	2.86	3.52	3.52	2.77	3.51	4.73	4.73	3.47	2.69	2.69	2.69	3.10	3.54	4.14	4.14	3.86	4.36	5.57	5.57	4.85
	13.0	2.46	3.25	3.25	2.46	3.02	4.34	4.37	3.08	2.43	2.55	2.55	2.75	3.05	3.82	3.82	3.43	3.75	5.15	5.15	4.31
	13.5	2.12	3.02	3.02	2.20	2.61	3.93	4.05	2.75	2.11	2.42	2.42	2.46	2.63	3.55	3.55	3.06	3.24	4.78	4.78	3.85
	14.0	1.84	2.80	2.80	1.97	2.27	3.55	3.77	2.47	1.84	2.30	2.30	2.20	2.28	3.30	3.30	2.75	2.81	4.38	4.44	3.45
LAPPED 20% END	11.0	4.56	5.22	5.22	4.18	5.69	7.01	7.01	5.24	3.63	3.63	3.64	4.68	5.61	5.89	5.89	5.83	7.04	8.26	8.26	7.32
	11.5	3.96	4.77	4.77	3.66	4.92	6.41	6.41	4.59	3.44	3.44	3.43	4.09	4.90	5.54	5.54	5.10	6.08	7.56	7.56	6.41
	12.0	3.43	4.38	4.38	3.22	4.24	5.83	5.89	4.04	3.26	3.26	3.26	3.60	4.25	5.15	5.15	4.49	5.25	6.94	6.94	5.64
	12.5	2.96	4.04	4.04	2.85	3.64	5.23	5.43	3.57	2.90	3.09	3.09	3.19	3.67	4.75	4.75	3.97	4.51	6.40	6.40	4.99
	13.0	2.54	3.69	3.74	2.53	3.12	4.70	5.02	3.17	2.52	2.94	2.94	2.83	3.15	4.39	4.39	3.53	3.87	5.78	5.92	4.44
	13.5	2.19	3.34	3.46	2.26	2.70	4.22	4.65	2.83	2.19	2.80	2.80	2.53	2.72	4.07	4.07	3.15	3.34	5.20	5.49	3.96
	14.0	1.90	3.01	3.22	2.03	2.34	3.80	4.33	2.54	1.91	2.67	2.67	2.27	2.36	3.71	3.79	2.83	2.90	4.69	5.10	3.55
LAPPED 10% INTERNAL	11.0	5.59	6.00	6.00	8.95	7.05	8.06	8.06	11.23	3.95	3.95	3.94	10.02	6.26	6.26	6.26	12.48	8.69	9.50	9.50	15.69
	11.5	4.91	5.49	5.49	7.83	6.16	7.37	7.37	9.82	3.72	3.73	3.73	8.77	5.87	5.87	5.87	10.93	7.60	8.69	8.69	13.73
	12.0	4.31	5.04	5.04	6.90	5.38	6.77	6.77	8.65	3.52	3.52	3.52	7.72	5.33	5.51	5.51	9.61	6.64	7.98	7.98	12.09
	12.5	3.78	4.64	4.64	6.10	4.69	6.24	6.24	7.65	3.33	3.33	3.33	6.83	4.67	5.18	5.18	8.51	5.80	7.36	7.36	10.69
	13.0	3.30	4.29	4.29	5.42	4.08	5.69	5.77	6.80	3.16	3.16	3.16	6.07	4.09	4.89	4.89	7.56	5.05	6.80	6.80	9.51
	13.5	2.88	3.98	3.98	4.84	3.55	5.14	5.35	6.07	2.83	3.00	3.00	5.42	3.57	4.61	4.61	6.75	4.39	6.31	6.31	8.49
	14.0	2.50	3.66	3.70	4.34	3.08	4.64	4.97	5.45	2.47	2.85	2.85	4.86	3.10	4.36	4.36	6.05	3.80	5.72	5.86	7.61

ULTIMATE UNIFORMLY DISTRIBUTED LOAD: 14.5 – 17.5 M

		HST 300/15				HST 300/18				HST 300/24				HST 300/30				HST 350/18			
		$\phi_b w_{bx}$		w_s		$\phi_b w_{bx}$		w_s		$\phi_b w_{bx}$		w_s		$\phi_b w_{bx}$		w_s		$\phi_b w_{bx}$		w_s	
		(kN/m)				(kN/m)				(kN/m)				(kN/m)				(kN/m)			
SPAN	(M)	1B	2B	3B	DEF	1B	2B	3B	DEF	1B	2B	3B	DEF	1B	2B	3B	DEF	1B	2B	3B	DEF
SINGLE SPAN	14.5	0.35	0.66	0.77	0.36	0.44	0.83	1.00	0.44	0.60	1.21	1.52	0.61	0.75	1.50	2.01	0.77	0.56	1.07	1.21	0.64
	15.0	0.31	0.59	0.72	0.33	0.38	0.74	0.93	0.40	0.52	1.08	1.42	0.55	0.66	1.34	1.84	0.69	0.49	0.95	1.13	0.58
	15.5	0.27	0.53	0.67	0.29	0.34	0.66	0.87	0.36	0.46	0.96	1.32	0.50	0.58	1.18	1.68	0.63	0.43	0.85	1.06	0.52
	16.0	0.24	0.47	0.63	0.27	0.30	0.59	0.82	0.33	0.41	0.85	1.21	0.46	0.51	1.05	1.55	0.57	0.38	0.76	0.99	0.48
	16.5	0.22	0.42	0.59	0.24	0.26	0.53	0.77	0.30	0.36	0.75	1.12	0.42	0.46	0.93	1.42	0.52	0.34	0.68	0.93	0.44
	17.0	0.19	0.38	0.56	0.22	0.24	0.47	0.71	0.27	0.32	0.67	1.03	0.38	0.41	0.83	1.30	0.47	0.30	0.61	0.88	0.40
	17.5	0.17	0.34	0.52	0.21	0.21	0.42	0.65	0.25	0.29	0.60	0.95	0.35	0.37	0.74	1.20	0.44	0.27	0.54	0.82	0.36
DOUBLE SPAN	14.5	0.70	0.77	0.77	0.87	0.88	1.00	1.00	1.06	1.28	1.52	1.52	1.47	1.62	2.03	2.03	1.84	1.12	1.21	1.21	1.54
	15.0	0.63	0.72	0.72	0.78	0.79	0.93	0.93	0.96	1.16	1.42	1.42	1.33	1.45	1.90	1.90	1.66	1.01	1.13	1.13	1.39
	15.5	0.57	0.67	0.67	0.71	0.71	0.87	0.87	0.87	1.04	1.33	1.33	1.21	1.30	1.75	1.78	1.51	0.91	1.06	1.06	1.26
	16.0	0.51	0.63	0.63	0.64	0.64	0.82	0.82	0.79	0.94	1.25	1.25	1.10	1.17	1.61	1.67	1.37	0.82	0.99	0.99	1.15
	16.5	0.46	0.59	0.59	0.59	0.58	0.77	0.77	0.72	0.84	1.16	1.17	1.00	1.05	1.48	1.57	1.25	0.74	0.93	0.93	1.05
	17.0	0.41	0.56	0.56	0.54	0.52	0.72	0.72	0.66	0.75	1.07	1.11	0.91	0.94	1.36	1.48	1.14	0.66	0.88	0.88	0.96
	17.5	0.37	0.53	0.53	0.49	0.46	0.68	0.68	0.60	0.67	0.99	1.04	0.84	0.84	1.26	1.40	1.05	0.59	0.83	0.83	0.88
CONTINUOUS END	14.5	0.67	0.90	0.90	0.68	0.84	1.16	1.16	0.84	1.20	1.75	1.77	1.16	1.49	2.23	2.37	1.45	1.08	1.41	1.41	1.21
	15.0	0.59	0.84	0.84	0.62	0.74	1.09	1.09	0.76	1.05	1.59	1.66	1.05	1.31	2.03	2.22	1.31	0.95	1.31	1.31	1.09
	15.5	0.52	0.79	0.79	0.56	0.66	1.00	1.02	0.68	0.93	1.46	1.55	0.95	1.15	1.85	2.08	1.18	0.84	1.23	1.23	0.99
	16.0	0.47	0.73	0.74	0.51	0.58	0.92	0.95	0.62	0.82	1.34	1.46	0.86	1.02	1.69	1.95	1.08	0.75	1.16	1.16	0.90
	16.5	0.42	0.67	0.69	0.46	0.52	0.84	0.90	0.57	0.73	1.22	1.37	0.79	0.91	1.54	1.83	0.98	0.67	1.06	1.09	0.82
	17.0	0.37	0.61	0.65	0.42	0.47	0.77	0.84	0.52	0.65	1.12	1.29	0.72	0.81	1.41	1.73	0.90	0.60	0.98	1.02	0.75
	17.5	0.33	0.56	0.62	0.39	0.42	0.70	0.80	0.48	0.58	1.03	1.22	0.66	0.73	1.28	1.61	0.82	0.53	0.90	0.97	0.69
CONTINUOUS INTERNAL	14.5	0.84	1.11	1.11	1.48	1.05	1.44	1.44	1.82	1.52	2.15	2.19	2.52	1.89	2.74	2.94	3.15	1.35	1.74	1.74	2.64
	15.0	0.74	1.04	1.04	1.34	0.93	1.34	1.34	1.64	1.33	1.96	2.05	2.28	1.66	2.49	2.75	2.85	1.19	1.63	1.63	2.39
	15.5	0.65	0.97	0.97	1.21	0.82	1.23	1.26	1.49	1.17	1.79	1.92	2.07	1.46	2.27	2.57	2.58	1.05	1.52	1.52	2.16
	16.0	0.58	0.89	0.91	1.10	0.73	1.12	1.18	1.35	1.04	1.64	1.80	1.88	1.29	2.07	2.41	2.35	0.94	1.42	1.43	1.97
	16.5	0.52	0.82	0.86	1.01	0.65	1.03	1.11	1.24	0.92	1.50	1.70	1.71	1.15	1.89	2.27	2.14	0.83	1.30	1.34	1.79
	17.0	0.47	0.75	0.81	0.92	0.58	0.94	1.05	1.13	0.82	1.37	1.60	1.57	1.03	1.72	2.13	1.96	0.75	1.20	1.27	1.64
	17.5	0.42	0.69	0.76	0.84	0.52	0.86	0.99	1.04	0.73	1.25	1.51	1.44	0.92	1.57	1.98	1.79	0.67	1.10	1.20	1.50
LAPPED 10% END	14.5	0.71	1.09	1.09	0.71	0.89	1.38	1.41	0.87	1.26	2.00	2.15	1.21	1.56	2.54	2.88	1.51	1.15	1.70	1.70	1.27
	15.0	0.63	0.99	1.02	0.64	0.79	1.25	1.31	0.79	1.10	1.82	2.01	1.09	1.37	2.30	2.69	1.37	1.01	1.58	1.59	1.14
	15.5	0.56	0.91	0.95	0.58	0.70	1.14	1.23	0.72	0.97	1.66	1.88	0.99	1.20	2.09	2.52	1.24	0.89	1.44	1.49	1.04
	16.0	0.50	0.83	0.89	0.53	0.62	1.04	1.16	0.65	0.86	1.51	1.77	0.90	1.07	1.88	2.34	1.13	0.79	1.32	1.40	0.94
	16.5	0.44	0.75	0.84	0.48	0.55	0.94	1.09	0.59	0.76	1.36	1.66	0.82	0.95	1.69	2.16	1.03	0.71	1.20	1.32	0.86
	17.0	0.40	0.67	0.79	0.44	0.50	0.84	1.02	0.54	0.68	1.23	1.56	0.75	0.85	1.51	1.99	0.94	0.63	1.09	1.24	0.79
	17.5	0.36	0.61	0.75	0.41	0.45	0.76	0.97	0.50	0.61	1.10	1.45	0.69	0.76	1.35	1.84	0.86	0.57	0.98	1.17	0.72
LAPPED 20% END	14.5	0.74	1.17	1.25	0.73	0.93	1.47	1.62	0.90	1.30	2.14	2.47	1.25	1.61	2.69	3.29	1.56	1.19	1.87	1.96	1.30
	15.0	0.65	1.06	1.17	0.66	0.82	1.33	1.51	0.81	1.14	1.93	2.31	1.13	1.41	2.41	3.02	1.41	1.05	1.70	1.83	1.18
	15.5	0.58	0.95	1.09	0.60	0.72	1.20	1.41	0.74	1.00	1.74	2.16	1.02	1.24	2.17	2.77	1.27	0.93	1.53	1.71	1.07
	16.0	0.51	0.86	1.03	0.54	0.64	1.08	1.33	0.67	0.88	1.57	1.99	0.93	1.10	1.94	2.55	1.16	0.82	1.38	1.61	0.97
	16.5	0.46	0.77	0.96	0.50	0.57	0.97	1.25	0.61	0.78	1.41	1.84	0.85	0.98	1.74	2.34	1.06	0.73	1.25	1.51	0.88
	17.0	0.41	0.70	0.91	0.45	0.51	0.87	1.16	0.56	0.70	1.26	1.70	0.77	0.87	1.55	2.15	0.97	0.65	1.12	1.42	0.81
	17.5	0.37	0.62	0.85	0.42	0.46	0.78	1.07	0.51	0.63	1.12	1.56	0.71	0.78	1.39	1.98	0.89	0.59	1.01	1.34	0.74
LAPPED 10% INTERNAL	14.5	0.96	1.43	1.43	1.57	1.20	1.80	1.86	1.93	1.70	2.62	2.84	2.67	2.11	3.32	3.80	3.34	1.54	2.14	2.14	2.79
	15.0	0.84	1.30	1.34	1.42	1.06	1.63	1.74	1.74	1.49	2.38	2.65	2.41	1.85	3.00	3.55	3.01	1.35	2.03	2.03	2.52
	15.5	0.75	1.18	1.26	1.28	0.94	1.48	1.63	1.58	1.31	2.16	2.48	2.19	1.63	2.72	3.32	2.73	1.20	1.89	1.93	2.29
	16.0	0.66	1.08	1.18	1.17	0.83	1.35	1.53	1.43	1.16	1.96	2.33	1.99	1.45	2.46	3.06	2.48	1.06	1.72	1.84	2.08
	16.5	0.59	0.98	1.11	1.07	0.74	1.22	1.43	1.31	1.03	1.78	2.19	1.81	1.29	2.22	2.83	2.26	0.95	1.57	1.74	1.90
	17.0	0.53	0.89	1.04	0.97	0.66	1.11	1.35	1.19	0.92	1.62	2.04	1.66	1.15	2.01	2.61	2.07	0.85	1.42	1.64	1.73
	17.5	0.48	0.80	0.99	0.89	0.60	1.01	1.28	1.09	0.82	1.46	1.89	1.52	1.03	1.81	2.41	1.90	0.76	1.29	1.54	1.59

ULTIMATE UNIFORMLY DISTRIBUTED LOAD: 14.5 – 17.5 M

SPAN		HST 350/24				HST 350/30				HST 400/20				HST 400/24				HST 400/30			
		$\phi_b w_{bx}$				w_s	$\phi_b w_{bx}$				w_s	$\phi_b w_{bx}$				w_s	$\phi_b w_{bx}$				w_s
		(kN/m)					(kN/m)					(kN/m)					(kN/m)				
		(M)	1B	2B	3B	DEF	1B	2B	3B	DEF	1B	2B	3B	DEF	1B	2B	3B	DEF	1B	2B	3B
SINGLE SPAN	14.5	0.76	1.54	1.85	0.90	0.94	1.92	2.48	1.12	0.77	1.49	1.64	1.00	0.94	1.91	2.17	1.25	1.17	2.37	2.93	1.57
	15.0	0.67	1.38	1.73	0.81	0.83	1.70	2.32	1.02	0.68	1.34	1.53	0.91	0.82	1.71	2.03	1.13	1.02	2.11	2.74	1.42
	15.5	0.59	1.23	1.62	0.73	0.73	1.51	2.13	0.92	0.59	1.20	1.44	0.82	0.72	1.52	1.90	1.02	0.90	1.88	2.56	1.29
	16.0	0.52	1.09	1.52	0.67	0.65	1.34	1.96	0.84	0.52	1.07	1.35	0.75	0.64	1.35	1.79	0.93	0.80	1.66	2.41	1.17
	16.5	0.46	0.97	1.42	0.61	0.57	1.19	1.80	0.76	0.46	0.96	1.27	0.68	0.57	1.20	1.68	0.85	0.71	1.47	2.21	1.07
	17.0	0.41	0.86	1.30	0.56	0.51	1.06	1.65	0.70	0.41	0.85	1.19	0.62	0.51	1.07	1.58	0.78	0.63	1.31	2.04	0.98
	17.5	0.37	0.77	1.20	0.51	0.46	0.94	1.52	0.64	0.37	0.77	1.13	0.57	0.45	0.95	1.48	0.71	0.56	1.17	1.87	0.89
DOUBLE SPAN	14.5	1.63	1.85	1.85	2.15	2.04	2.48	2.48	2.70	1.57	1.64	1.64	2.41	2.01	2.17	2.17	3.00	2.52	2.93	2.93	3.78
	15.0	1.47	1.73	1.73	1.95	1.83	2.32	2.32	2.44	1.41	1.53	1.53	2.18	1.81	2.03	2.03	2.71	2.26	2.74	2.74	3.41
	15.5	1.32	1.62	1.62	1.76	1.65	2.17	2.17	2.21	1.28	1.43	1.43	1.97	1.63	1.90	1.90	2.46	2.03	2.56	2.56	3.09
	16.0	1.19	1.52	1.52	1.60	1.48	2.03	2.04	2.01	1.15	1.35	1.35	1.80	1.47	1.79	1.79	2.24	1.82	2.41	2.41	2.81
	16.5	1.07	1.43	1.43	1.46	1.32	1.87	1.92	1.83	1.04	1.27	1.27	1.64	1.32	1.68	1.68	2.04	1.63	2.26	2.26	2.56
	17.0	0.95	1.35	1.35	1.34	1.18	1.72	1.81	1.68	0.93	1.19	1.19	1.50	1.18	1.58	1.58	1.86	1.45	2.12	2.13	2.34
	17.5	0.85	1.25	1.27	1.23	1.06	1.59	1.71	1.54	0.84	1.13	1.13	1.37	1.05	1.49	1.49	1.71	1.30	1.96	2.01	2.15
CONTINUOUS END	14.5	1.53	2.16	2.16	1.70	1.89	2.82	2.90	2.13	1.52	1.88	1.88	1.90	1.90	2.54	2.54	2.36	2.34	3.42	3.42	2.97
	15.0	1.34	2.02	2.02	1.53	1.66	2.57	2.71	1.92	1.34	1.78	1.78	1.71	1.66	2.37	2.37	2.14	2.05	3.16	3.19	2.68
	15.5	1.18	1.85	1.89	1.39	1.46	2.35	2.54	1.74	1.18	1.67	1.67	1.55	1.46	2.22	2.22	1.94	1.81	2.89	2.99	2.43
	16.0	1.04	1.69	1.77	1.26	1.29	2.14	2.38	1.58	1.05	1.57	1.57	1.41	1.29	2.08	2.08	1.76	1.60	2.64	2.81	2.21
	16.5	0.93	1.55	1.67	1.15	1.15	1.96	2.24	1.44	0.93	1.48	1.48	1.29	1.15	1.91	1.96	1.60	1.42	2.41	2.64	2.02
	17.0	0.82	1.42	1.57	1.05	1.02	1.79	2.11	1.32	0.84	1.37	1.39	1.18	1.02	1.75	1.85	1.47	1.26	2.20	2.49	1.84
	17.5	0.74	1.30	1.48	0.96	0.92	1.63	1.99	1.21	0.75	1.26	1.31	1.08	0.91	1.61	1.74	1.34	1.13	2.01	2.35	1.69
CONTINUOUS INTERNAL	14.5	1.94	2.67	2.67	3.69	2.39	3.46	3.59	4.63	1.90	2.28	2.28	4.13	2.40	3.14	3.14	5.15	2.96	4.23	4.23	6.48
	15.0	1.70	2.48	2.50	3.34	2.10	3.16	3.35	4.19	1.68	2.17	2.17	3.74	2.11	2.93	2.93	4.65	2.60	3.89	3.96	5.85
	15.5	1.50	2.27	2.34	3.03	1.85	2.88	3.14	3.79	1.48	2.06	2.06	3.39	1.85	2.75	2.75	4.22	2.29	3.55	3.70	5.30
	16.0	1.32	2.08	2.19	2.75	1.64	2.63	2.95	3.45	1.32	1.95	1.95	3.08	1.64	2.56	2.58	3.83	2.02	3.24	3.47	4.82
	16.5	1.17	1.90	2.06	2.51	1.45	2.40	2.77	3.15	1.17	1.83	1.83	2.81	1.45	2.35	2.43	3.50	1.79	2.95	3.27	4.40
	17.0	1.04	1.74	1.94	2.29	1.30	2.19	2.61	2.88	1.05	1.68	1.72	2.57	1.29	2.15	2.28	3.20	1.60	2.70	3.08	4.02
	17.5	0.93	1.59	1.83	2.10	1.16	2.00	2.46	2.64	0.94	1.54	1.63	2.35	1.15	1.97	2.16	2.93	1.43	2.46	2.90	3.68
LAPPED 10% END	14.5	1.60	2.54	2.61	1.77	1.98	3.22	3.51	2.22	1.61	2.19	2.18	1.98	1.99	3.07	3.07	2.47	2.45	3.97	4.14	3.11
	15.0	1.40	2.31	2.44	1.60	1.73	2.92	3.28	2.01	1.42	2.08	2.08	1.79	1.74	2.85	2.87	2.23	2.14	3.60	3.87	2.81
	15.5	1.23	2.10	2.29	1.45	1.53	2.65	3.07	1.82	1.25	1.98	1.98	1.62	1.53	2.60	2.69	2.02	1.89	3.27	3.62	2.54
	16.0	1.09	1.91	2.15	1.32	1.35	2.39	2.88	1.65	1.11	1.85	1.89	1.48	1.35	2.37	2.52	1.84	1.67	2.96	3.40	2.31
	16.5	0.97	1.74	2.02	1.20	1.20	2.15	2.71	1.51	0.99	1.68	1.79	1.35	1.20	2.15	2.37	1.68	1.48	2.66	3.20	2.11
	17.0	0.86	1.56	1.90	1.10	1.07	1.93	2.52	1.38	0.88	1.53	1.69	1.23	1.07	1.94	2.24	1.53	1.32	2.39	3.01	1.93
	17.5	0.77	1.40	1.79	1.01	0.96	1.73	2.33	1.26	0.78	1.38	1.59	1.13	0.95	1.74	2.11	1.41	1.18	2.14	2.84	1.77
LAPPED 20% END	14.5	1.65	2.72	3.00	1.82	2.04	3.41	4.03	2.29	1.67	2.54	2.54	2.04	2.05	3.35	3.53	2.54	2.53	4.22	4.76	3.20
	15.0	1.45	2.45	2.81	1.65	1.79	3.07	3.77	2.07	1.47	2.36	2.43	1.84	1.80	3.03	3.30	2.30	2.21	3.79	4.44	2.89
	15.5	1.28	2.21	2.63	1.49	1.58	2.76	3.50	1.87	1.30	2.14	2.32	1.67	1.58	2.74	3.09	2.08	1.95	3.41	4.16	2.62
	16.0	1.13	2.00	2.47	1.36	1.40	2.47	3.22	1.70	1.15	1.94	2.19	1.52	1.40	2.47	2.90	1.89	1.72	3.06	3.91	2.38
	16.5	1.00	1.80	2.32	1.24	1.24	2.21	2.96	1.55	1.02	1.75	2.06	1.39	1.24	2.23	2.73	1.73	1.53	2.75	3.64	2.17
	17.0	0.89	1.61	2.14	1.13	1.10	1.98	2.73	1.42	0.90	1.58	1.94	1.27	1.10	2.00	2.57	1.58	1.36	2.46	3.35	1.98
	17.5	0.79	1.44	1.98	1.04	0.99	1.77	2.51	1.30	0.81	1.42	1.83	1.16	0.98	1.79	2.42	1.45	1.22	2.20	3.09	1.82
LAPPED 10% INTERNAL	14.5	2.18	3.32	3.45	3.91	2.69	4.20	4.64	4.90	2.17	2.71	2.71	4.37	2.70	4.06	4.06	5.45	3.32	5.18	5.47	6.85
	15.0	1.91	3.02	3.22	3.53	2.35	3.81	4.33	4.43	1.91	2.58	2.58	3.95	2.36	3.73	3.79	4.92	2.91	4.69	5.11	6.19
	15.5	1.68	2.74	3.02	3.20	2.07	3.45	4.06	4.01	1.69	2.46	2.46	3.58	2.08	3.39	3.55	4.46	2.56	4.25	4.78	5.61
	16.0	1.48	2.49	2.83	2.91	1.83	3.12	3.81	3.65	1.50	2.35	2.35	3.25	1.84	3.08	3.33	4.06	2.27	3.86	4.49	5.10
	16.5	1.31	2.27	2.66	2.65	1.63	2.83	3.57	3.33	1.33	2.19	2.25	2.97	1.63	2.80	3.13	3.70	2.01	3.49	4.22	4.65
	17.0	1.17	2.06	2.51	2.42	1.45	2.56	3.30	3.04	1.19	2.00	2.15	2.71	1.45	2.55	2.95	3.38	1.79	3.16	3.98	4.25
	17.5	1.05	1.87	2.37	2.22	1.30	2.31	3.05	2.79	1.06	1.82	2.06	2.49	1.29	2.31	2.79	3.10	1.60	2.86	3.75	3.90

AXIAL LOAD TABLES

ULTIMATE AXIAL COMPRESSION LOAD – CONCENTRIC

HST 150

SPAN (M)	HST 150/12				HST 150/15				HST 150/18			
	$\phi_c N_c$			N_{ex}	$\phi_c N_c$			N_{ex}	$\phi_c N_c$			N_{ex}
	(kN)			(kN)	(kN)			(kN)	(kN)			(kN)
	OB	1B	2B		OB	1B	2B		OB	1B	2B	
4.0	28.12	75.29	75.29	170.11	35.24	103.92	103.92	212.20	42.43	131.57	141.08	253.31
4.5	22.45	74.08	75.29	134.40	28.30	100.24	103.92	167.60	34.29	115.45	141.08	200.11
5.0	18.39	65.47	75.29	108.90	23.32	85.70	103.92	135.80	28.46	99.94	141.08	162.11
5.5		56.93	75.29	89.96		71.85	103.92	112.20		85.31	141.08	134.00
6.0		48.86	75.29	75.60		60.82	103.92	94.31		72.39	131.36	112.60
6.5		41.96	75.29	64.42		52.20	103.92	80.35		62.30	120.55	95.93
7.0		36.36	71.08	55.54		45.33	95.31	69.28		54.25	109.97	82.71
7.5		31.83	65.33	48.39		39.78	85.48	60.35		47.76	99.70	72.05
8.0		28.12	59.56	42.53		35.24	76.00	53.04		42.43	89.87	63.33
8.5		25.04	53.92	37.67		31.46	67.64	46.99		38.00	80.40	56.11
9.0		22.45	48.73	33.60		28.30	60.64	41.91		34.29	72.18	50.04
9.5		20.26	43.99	30.16		25.61	54.68	37.62		31.15	65.21	44.91
10.0		18.39	39.83	27.22		23.32	49.59	33.95		28.46	59.25	40.53
10.5			36.25	24.69			45.20	30.79			54.11	36.76

HST 200

SPAN (M)	HST 200/12				HST 200/15				HST 200/18			
	$\phi_c N_c$			N_{ex}	$\phi_c N_c$			N_{ex}	$\phi_c N_c$			N_{ex}
	(kN)			(kN)	(kN)			(kN)	(kN)			(kN)
	OB	1B	2B		OB	1B	2B		OB	1B	2B	
4.0	42.43	78.86	78.86	370.11	52.86	109.85	109.85	462.51	63.10	133.46	133.46	553.11
4.5	33.75	78.86	78.86	292.40	42.13	109.85	109.85	365.40	50.46	133.46	133.46	437.00
5.0	27.50	78.86	78.86	236.91	34.44	109.85	109.85	296.00	41.39	133.46	133.46	354.00
5.5	22.87	76.34	78.86	195.80	28.73	105.72	109.85	244.60	34.67	126.09	133.46	292.51
6.0		67.72	78.86	164.51		91.71	109.85	205.51		109.40	133.46	245.80
6.5		60.05	78.86	140.20		79.03	109.85	175.11		93.89	133.46	209.51
7.0		53.63	78.86	120.80		68.45	109.85	151.00		81.44	133.46	180.60
7.5		47.63	78.86	105.31		59.89	109.85	131.51		71.37	133.46	157.31
8.0		42.43	78.86	92.53		52.85	109.70	115.60		63.10	131.56	138.31
8.5		37.73	73.33	81.96		47.02	101.04	102.40		56.23	120.11	122.51
9.0		33.75	67.56	73.11		42.13	91.46	91.35		50.46	109.08	109.31
9.5		30.38	62.30	65.61		37.98	82.87	81.99		45.57	98.42	98.06
10.0		27.50	57.65	59.22		34.44	75.01	73.99		41.39	89.15	88.49
10.5		25.02	53.50	53.71		31.38	68.24	67.11		37.79	81.21	80.27

HST 250

SPAN (M)	HST 250/13				HST 250/15				HST 250/18			
	$\phi_c N_c$			N_{ex}	$\phi_c N_c$			N_{ex}	$\phi_c N_c$			N_{ex}
	(kN)			(kN)	(kN)			(kN)	(kN)			(kN)
	1B	2B	3B		1B	2B	3B		1B	2B	3B	
4.0	96.33	96.33	96.33	722.11	119.70	119.70	119.70	833.40	147.39	147.39	147.39	998.31
4.5	96.33	96.33	96.33	570.60	119.70	119.70	119.70	658.51	147.39	147.39	147.39	788.71
5.0	96.33	96.33	96.33	462.20	119.70	119.70	119.70	533.40	147.39	147.39	147.39	638.91
5.5	96.33	96.33	96.33	381.91	119.70	119.70	119.70	440.80	147.39	147.39	147.39	528.00
6.0	96.33	96.33	96.33	320.91	119.70	119.70	119.70	370.40	147.39	147.39	147.39	443.71
6.5	92.89	96.33	96.33	273.51	114.84	119.70	119.70	315.60	144.08	147.39	147.39	378.00
7.0	83.59	96.33	96.33	235.80	102.98	119.70	119.70	272.11	127.35	147.39	147.39	326.00
7.5	75.49	96.33	96.33	205.40	92.46	119.70	119.70	237.11	111.50	147.39	147.39	283.91
8.0	68.53	96.33	96.33	180.51	82.42	119.70	119.70	208.40	98.53	147.39	147.39	249.60
8.5	62.50	96.33	96.33	159.91	73.72	119.70	119.70	184.60	87.72	147.39	147.39	221.11
9.0	56.70	96.33	96.33	142.60	65.98	119.70	119.70	164.60	78.60	147.39	147.39	197.20
9.5	51.47	95.84	96.33	128.00	59.44	118.54	119.70	147.80	70.87	147.39	147.39	177.00
10.0	46.78	89.53	96.33	115.51	53.82	110.54	119.70	133.40	64.25	138.37	147.39	159.71
10.5	42.54	83.40	96.33	104.80	48.98	102.74	119.70	121.00	58.53	126.95	147.39	144.91

ULTIMATE AXIAL LOAD – CONCENTRIC

HST 300

SPAN (M)	HST 300/15				HST 300/18				HST 300/24				HST 300/30			
	$\phi_c N_c$			N_{ex}	$\phi_c N_c$			N_{ex}	$\phi_c N_c$			N_{ex}	$\phi_c N_c$			N_{ex}
	(kN)			(kN)	(kN)			(kN)	(kN)			(kN)	(kN)			(kN)
	1B	2B	3B		1B	2B	3B		1B	2B	3B		1B	2B	3B	
5.0	121.16	121.16	121.16	904.80	159.25	159.25	159.25	1085.00	247.70	247.70	247.70	1466.00	347.45	347.45	347.45	1809.00
5.5	121.16	121.16	121.16	747.80	159.25	159.25	159.25	896.60	247.70	247.70	247.70	1212.00	347.45	347.45	347.45	1495.00
6.0	121.16	121.16	121.16	628.31	159.25	159.25	159.25	753.40	247.70	247.70	247.70	1018.00	347.45	347.45	347.45	1256.00
6.5	121.16	121.16	121.16	535.40	159.25	159.25	159.25	641.91	247.70	247.70	247.70	867.80	341.50	347.45	347.45	1070.00
7.0	121.16	121.16	121.16	461.60	159.25	159.25	159.25	553.51	247.70	247.70	247.70	748.20	309.65	347.45	347.45	922.80
7.5	121.16	121.16	121.16	402.11	159.25	159.25	159.25	482.11	229.26	247.70	247.70	651.80	279.00	347.45	347.45	803.91
8.0	114.48	121.16	121.16	353.40	149.46	159.25	159.25	423.80	205.35	247.70	247.70	572.91	249.40	347.45	347.45	706.51
8.5	104.09	121.16	121.16	313.11	135.73	159.25	159.25	375.40	182.88	247.70	247.70	507.40	222.48	347.45	347.45	625.91
9.0	96.42	121.16	121.16	279.31	122.60	159.25	159.25	334.80	163.98	247.70	247.70	452.60	199.77	347.45	347.45	558.20
9.5	88.92	121.16	121.16	250.60	110.92	159.25	159.25	300.51	147.93	247.70	247.70	406.20	180.45	347.45	347.45	501.00
10.0	82.26	121.16	121.16	226.20	100.45	159.25	159.25	271.20	134.15	247.70	247.70	366.60	163.97	330.18	347.45	452.20
10.5	75.70	121.16	121.16	205.20	91.39	159.25	159.25	246.00	122.26	247.70	247.70	332.51	149.70	308.98	347.45	410.11
11.0	69.64	121.16	121.16	186.91	83.52	159.25	159.25	224.11	111.93	236.84	247.70	303.00	137.28	288.40	347.45	373.71
11.5	64.20	120.58	121.16	171.00	76.64	157.84	159.25	205.11	102.89	220.59	247.70	277.20	126.40	268.40	347.45	341.91
12.0	59.08	114.23	121.16	157.11	70.59	149.14	159.25	188.31	94.93	204.74	247.70	254.60	116.88	248.70	347.45	314.00
12.5	54.57	107.76	121.16	144.80	65.23	140.17	159.25	173.60	87.91	189.35	247.70	234.60	108.40	230.20	343.30	289.40
13.0	50.56	101.72	121.16	133.80	60.49	130.76	159.25	160.51	81.65	175.71	247.70	216.91	100.90	213.80	326.60	267.60
13.5	46.98	96.20	121.16	124.11	56.24	122.26	159.25	148.80	76.08	163.49	247.70	201.20	94.22	199.17	310.20	248.11
14.0	43.78	91.10	121.16	115.40	52.45	114.44	159.25	138.40	71.08	152.55	241.49	187.11	88.22	186.05	294.14	230.71
14.5	40.88	86.42	121.16	107.60	49.03	106.93	159.25	129.00	66.58	142.69	228.80	174.40	82.81	174.20	278.40	215.11
15.0	38.29	82.05	118.88	100.51	45.94	100.14	155.50	120.51	62.52	133.77	216.30	162.91	77.93	163.49	263.14	201.00
15.5		77.68	113.96	94.15		93.98	148.77	112.91		125.68	204.01	152.60		153.78	247.85	188.20
16.0		73.38	108.90	88.36		88.36	141.81	105.91		118.32	192.03	143.20		144.96	233.38	176.60
16.5		69.44	104.10	83.09		83.26	134.47	99.62		111.61	181.05	134.71		136.90	220.27	166.11
17.0		65.82	99.62	78.27		78.60	127.49	93.84		105.44	171.02	126.91		129.50	208.20	156.51
17.5		62.23	95.43	73.86		74.32	121.07	88.56		99.84	161.84	119.71		122.76	197.15	147.71

HST 350

SPAN (M)	HST 350/18				HST 350/24				HST 350/30			
	$\phi_c N_c$			N_{ex}	$\phi_c N_c$			N_{ex}	$\phi_c N_c$			N_{ex}
	(kN)			(kN)	(kN)			(kN)	(kN)			(kN)
	1B	2B	3B		1B	2B	3B		1B	2B	3B	
5.0	158.10	158.10	158.10	1584.00	248.00	248.00	248.00	2994.00	339.90	339.90	339.90	2648.00
5.5	158.10	158.10	158.10	1309.00	248.00	248.00	248.00	2475.00	339.90	339.90	339.90	2188.00
6.0	158.10	158.10	158.10	1100.00	248.00	248.00	248.00	2079.00	339.90	339.90	339.90	1839.00
6.5	158.10	158.10	158.10	937.51	248.00	248.00	248.00	1772.00	339.90	339.90	339.90	1567.00
7.0	158.10	158.10	158.10	808.31	248.00	248.00	248.00	1528.00	339.90	339.90	339.90	1351.00
7.5	158.10	158.10	158.10	704.11	248.00	248.00	248.00	1331.00	309.90	339.90	339.90	1177.00
8.0	158.10	158.10	158.10	618.91	246.50	248.00	248.00	1170.00	277.20	339.90	339.90	1034.00
8.5	151.42	158.10	158.10	548.20	223.45	248.00	248.00	1036.00	247.32	339.90	339.90	916.11
9.0	136.87	158.10	158.10	489.00	200.70	248.00	248.00	924.20	222.00	339.90	339.90	817.20
9.5	123.93	158.10	158.10	438.91	181.10	248.00	248.00	829.40	200.55	339.90	339.90	733.40
10.0	112.20	158.10	158.10	396.11	164.20	248.00	248.00	748.60	182.07	339.90	339.90	661.91
10.5	102.10	158.10	158.10	359.31	149.60	248.00	248.00	679.00	166.15	339.90	339.90	600.40
11.0	93.30	158.10	158.10	327.31	136.90	248.00	248.00	618.60	152.28	320.27	339.90	547.00
11.5	85.61	158.10	158.10	299.51	125.80	248.00	248.00	566.00	140.10	298.22	339.90	500.51
12.0	78.83	158.10	158.10	275.11	115.98	245.90	248.00	519.80	129.43	276.46	339.90	459.60
12.5	72.84	155.65	158.10	253.51	107.30	230.10	248.00	479.11	119.95	255.99	339.90	424.31
13.0	67.52	146.03	158.10	234.40	99.58	215.10	248.00	442.91	111.54	237.70	339.90	391.70
13.5	62.75	136.50	158.10	217.31	92.67	200.18	248.00	410.71	104.00	221.40	339.90	363.20
14.0	58.51	127.84	158.10	202.11	86.49	186.70	248.00	381.91	97.27	206.76	326.60	337.71
14.5	54.67	119.45	158.10	188.40	80.91	174.60	248.00	356.00	91.20	193.50	309.30	314.80
15.0	51.21	111.88	158.10	176.00	75.87	163.70	248.00	332.71	85.72	181.56	292.40	294.20
15.5		104.98	158.10	164.91	71.31	153.80	245.20	311.60		170.73	275.55	275.51
16.0		98.73	157.37	154.71	67.15	144.75	232.90	292.40		160.80	259.50	258.60
16.5		93.03	150.16	145.51	63.37	136.50	221.50	275.00		151.80	244.85	243.11
17.0		87.80	142.38	137.11	59.90	128.96	209.30	259.00		143.57	231.44	229.00
17.5		83.01	135.18	129.31	56.73	122.00	198.10	244.40		136.00	219.10	216.11

ULTIMATE AXIAL LOAD – CONCENTRIC

HST 400

SPAN (M)	HST 400/20				HST 400/24				HST 400/30			
	N_c			N_{ex}	$\phi_c N_c$			N_{ex}	$\phi_c N_c$			N_{ex}
	(kN)			(kN)	(kN)			(kN)	(kN)			(kN)
	1B	2B	3B		1B	2B	3B		1B	2B	3B	
5.0	182.92	182.92	182.92	2454.00	248.00	248.00	248.00	2994.00	337.80	337.80	337.80	3700.00
5.5	182.92	182.92	182.92	2028.00	248.00	248.00	248.00	2475.00	337.80	337.80	337.80	3058.00
6.0	182.92	182.92	182.92	1704.00	248.00	248.00	248.00	2079.00	337.80	337.80	337.80	2570.00
6.5	182.92	182.92	182.92	1452.00	248.00	248.00	248.00	1772.00	337.80	337.80	337.80	2189.00
7.0	182.92	182.92	182.92	1252.00	248.00	248.00	248.00	1528.00	337.80	337.80	337.80	1888.00
7.5	182.92	182.92	182.92	1091.00	248.00	248.00	248.00	1331.00	337.80	337.80	337.80	1645.00
8.0	182.92	182.92	182.92	958.50	246.50	248.00	248.00	1170.00	304.20	337.80	337.80	1445.00
8.5	175.70	182.92	182.92	849.00	223.45	248.00	248.00	1036.00	271.40	337.80	337.80	1280.00
9.0	160.31	182.92	182.92	757.30	200.70	248.00	248.00	924.20	243.65	337.80	337.80	1142.00
9.5	146.88	182.92	182.92	679.70	181.10	248.00	248.00	829.40	220.00	337.80	337.80	1025.00
10.0	135.07	182.92	182.92	613.40	164.20	248.00	248.00	748.60	199.70	337.80	337.80	925.11
10.5	124.10	182.92	182.92	556.40	149.60	248.00	248.00	679.00	182.20	337.80	337.80	839.11
11.0	113.48	182.92	182.92	507.00	136.90	248.00	248.00	618.60	166.90	337.80	337.80	764.51
11.5	104.13	182.92	182.92	463.80	125.80	248.00	248.00	566.00	153.50	327.00	337.80	699.51
12.0	95.97	182.92	182.92	426.00	115.98	245.90	248.00	519.80	141.70	303.30	337.80	642.40
12.5	88.66	180.88	182.92	392.60	107.30	203.20	248.00	479.11	131.30	280.90	337.80	592.00
13.0	82.21	169.92	182.92	363.00	99.58	215.10	248.00	442.91	122.00	260.80	337.80	547.40
13.5	76.46	159.89	182.92	336.60	92.67	200.18	248.00	410.71	113.70	242.90	337.80	507.60
14.0	71.27	150.79	182.92	313.00	86.49	186.70	248.00	381.91	106.22	226.80	337.80	472.00
14.5	66.61	142.38	182.92	291.80	80.91	174.60	248.00	356.00	99.56	212.30	337.80	440.00
15.0	62.42	134.73	182.92	272.60	75.87	163.70	248.00	332.71	93.50	199.10	320.70	411.11
15.5		127.59	182.92	255.30		153.80	245.20	311.60		187.20	302.30	385.00
16.0		120.02	182.92	239.60		144.75	232.90	292.40		176.30	284.70	361.40
16.5		113.14	174.25	225.30		136.50	221.50	275.00		166.40	268.70	339.80
17.0		106.76	166.09	212.30		128.96	209.30	259.00		157.30	254.00	320.11
17.5		100.98	158.44	200.30		122.00	198.10	244.40		149.00	240.40	302.11
18.0		95.63	151.47	189.30		115.60	187.70	231.00		141.30	228.00	285.51

BOLT JOINT CAPACITY

The following table sets out the bolt connection capacity for the different steel thicknesses used with **HST** purlins when checked for bearing and end tearout.

BOLT SIZES	M12		M12 BOLT SHEAR		M16		M16 BOLT SHEAR	
	BEARING	TEAROUT	GRADE 4.6	GRADE 8.8	BEARING	TEAROUT	GRADE 4.6	GRADE 8.8
PLATE THICKNESS	(kN)	(kN)	(kN)	(kN)	(kN)	(kN)	(kN)	(kN)
(mm)								
1.15	12.7	13.6	15.1	31.4	15.0	13.6	28.6	59.3
1.25	14.0	14.8	15.1	31.4	17.0	14.8	28.6	59.3
1.45	16.3	17.2	15.1	31.4	21.0	17.2	28.6	59.3
1.75	18.1	19.2	15.1	31.4	24.2	19.2	28.6	59.3
1.95	20.2	21.3	15.1	31.4	27.0	21.3	28.6	59.3
2.4	24.9	26.3	15.1	31.4	33.2	26.3	28.6	59.3
3.0	49.8	49.3	15.1	31.4	66.4	49.3	28.6	59.3

Notes:

- The bearing and tearout capacities for thicknesses 1.15 - 2.4 are calculated in accordance with AS/NZS 4600. The bearing and tearout capacities for thickness 3.0 are calculated in accordance with NZS 3404.
- The capacities should only be used for the member subject to nominal ductility or no ductility demand.
- Washers should be used under both bolt head and nut, or flanged bolts should be used.
- A 38mm edge distance was assumed for tearout capacity calculations.
- The bolt capacities are based on AS 1111:2000 and AS 1252.
- M16 bolts are recommended to be used for cleat connection. The connection capacity should be checked by engineers when M12 bolts are used.

SPLICE JOINTS

SPLICE DESIGN

HST150

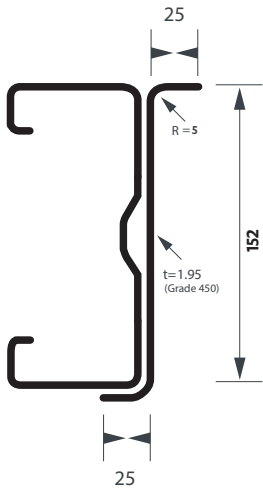

HST200

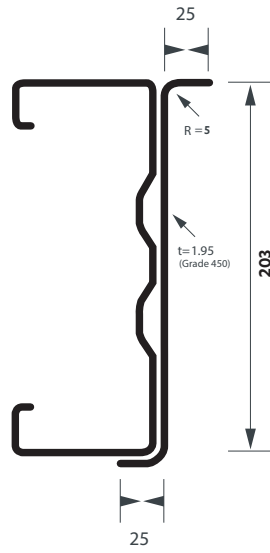

HST250

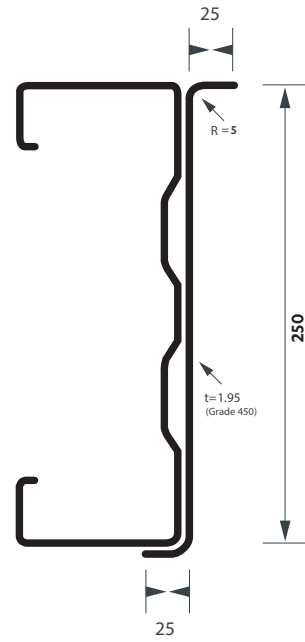

HST300

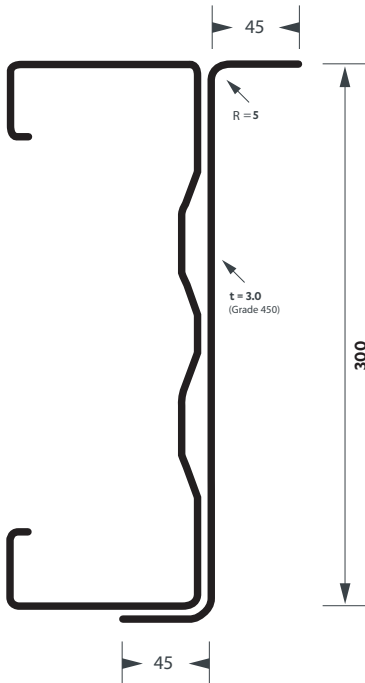

HST350

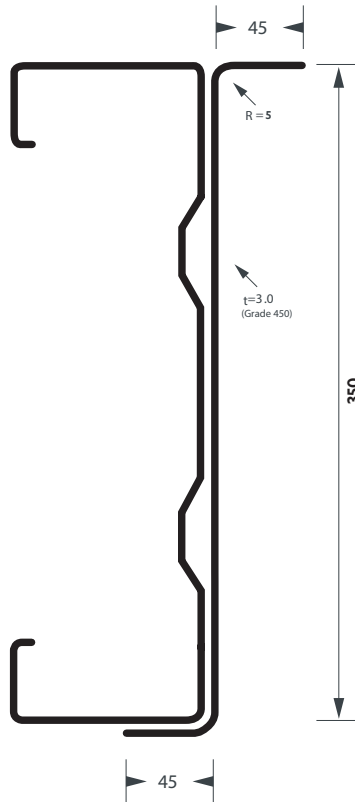

HST400

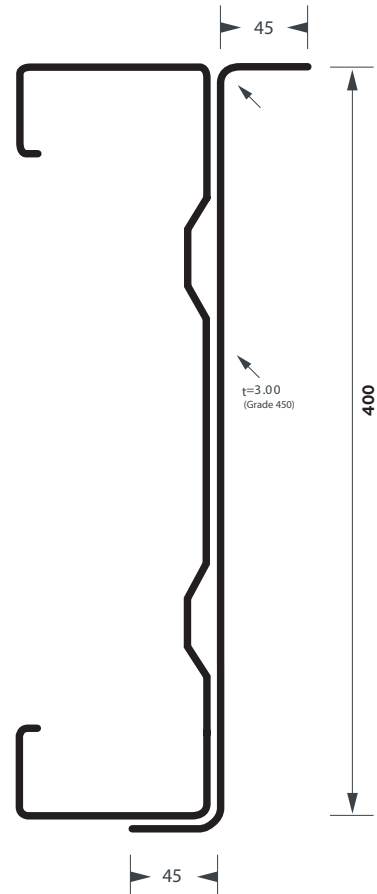

SPLICE JOINTS

SPLICE JOINTS CAPACITIES TABLE

The design moment and shear force at center of bolt groups should be less than the capacities given in the table.

HST	ϕM (kN.m)	ϕV_v (kN)	HST	ϕM (kN.m)	ϕV_v (kN)	HST	ϕM (kN.m)	ϕV_v (kN)
150/12	3.01	5.49	250/13	6.75	4.94	350/18	15.84	8.30
150/15	4.09	10.48	250/15	8.27	7.37	350/24	24.29	19.83
150/18	4.87	17.77	250/18	10.00	12.28	350/30	32.64	36.90
200/12	4.35	4.30	300/15	10.10	5.94	400/20	21.54	9.59
200/15	5.98	8.13	300/18	13.07	9.92	400/24	28.57	17.04
200/18	7.18	13.69	300/24	19.97	23.66	400/30	38.48	31.76
			300/30	26.73	43.96			

HOLE LOCATION

HST 150, HST 200, HST 250

Where axial load applies, specific design is required.

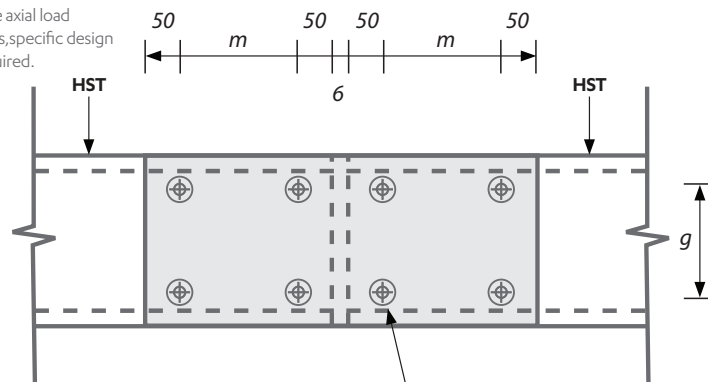

	g(mm)	m(mm)
HST 150	80	120
HST 200	120	120
HST 250	160	180

M16 Grade 4.6
Washers under both
bolt head and nut.

HST 300, HST 350, HST 400

Where axial load applies, specific design is required.

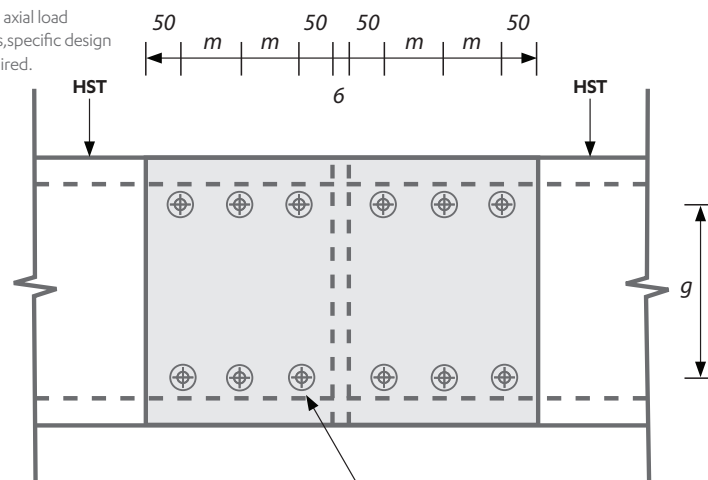

	g(mm)	m(mm)
HST 300	200	120
HST 350	240	120
HST 400	280	120

M16 Grade 4.6 for 1.45mm, 1.75mm and 1.85mm thick HST.
M16 Grade 8.8 for 2.4mm and 3mm thick HST
Washers under both bolt head and nut.

SECTIONAL PROPERTIES

PURLIN SIZE	AREA	WEIGHT	SECOND MOMENT OF AREA (GROSS SECTION)		SECTION MODULUS		RADIUS OF GYRATION		TORSION CONSTANT	WARPING FACTOR
	A_s	W_t	I_x	I_y	Z_x	Z_y	r_x	r_y	J	I_w
HST	MM ²	KN/M	10 ⁶ MM ⁴	10 ⁶ MM ⁴	10 ³ MM ³	10 ³ MM ³	MM	MM	MM ⁴	10 ⁹ MM ⁶
100/12	253	0.019	0.423	0.092	8.38	2.78	40.9	19.1	111	0.21
100/15	316	0.024	0.525	0.114	10.45	3.44	40.8	18.9	222	0.26
100/19	400	0.031	0.658	0.141	13.14	4.29	40.6	18.7	456	0.31
150/12	386	0.030	1.38	0.249	18.1	6.14	59.8	25.4	170	1.54
150/15	483	0.037	1.72	0.308	22.6	7.61	59.7	25.2	338	1.87
150/18	578	0.044	2.05	0.364	27.0	9.01	59.6	25.1	590	2.19
200/12	478	0.037	3.00	0.392	29.6	8.04	79.2	28.6	211	3.93
200/15	598	0.046	3.75	0.486	36.9	9.98	79.2	28.5	419	4.83
200/18	717	0.055	4.48	0.577	44.2	11.90	79.1	28.4	732	5.67
250/13	625	0.048	5.85	0.655	46.8	11.90	96.8	32.4	325	10.4
250/15	722	0.056	6.76	0.753	54.0	13.7	96.7	32.3	506	11.9
250/18	866	0.067	8.09	0.897	64.7	16.3	96.6	32.2	885	14.0
300/15	847	0.065	11.5	1.23	76.4	18.5	116	38.1	594	26.4
300/18	1018	0.078	13.7	1.46	91.6	22	116	37.9	1039	31.2
300/24	1382	0.106	18.6	1.95	124	29.5	116	37.6	2653	41.1
300/30	1711	0.132	22.9	2.38	153	36.0	116	37.3	5134	49.4
350/18	1123	0.086	20.1	1.63	115	24	134	38.1	1146	46.7
350/24	1526	0.117	27.2	2.17	155	32.1	133	37.7	2930	61.6
350/30	1891	0.146	33.5	2.65	192	39.3	133	37.4	5674	74.3
400/20	1365	0.105	31.1	1.97	155	28.6	151	38.0	1730	73.1
400/24	1670	0.128	37.9	2.39	190	34.7	151	37.8	3206	87.7
400/30	2071	0.159	46.9	2.92	234	42.5	150	37.5	6214	106

Note: All section properties are for the gross section.

SECTION CAPACITIES

PURLIN SIZE	SECTION MOMENT CAPACITY	DISTORTIONAL BUCKLING MOMENT CAPACITY	FLEXI-TORSIONAL BUCKLING MOMENT CAPACITY $\phi_b M_{fbx}$											SHEAR CAPACITY	AXIAL COMPRESSION SECTION CAPACITY
			EFFECTIVE LENGTH (LE) IN METRES (kN.m)												
HST	$\phi_b M_{sx}$ (kN.m)	$\phi_b M_{dbx}$ (kN.m)	2.0	3.0	4.0	5.0	6.0	7.0	8.0	9.0	10.0	11.0	12.0	$\phi_v V_v$ (kN)	$\phi_c N_s$ (kN)
150/12	7.0	6.0	5.7	3.7	2.2	1.5	1.0	0.8	0.6	0.5	0.4	0.4	0.3	13.7	125.7
150/15	9.7	8.2	7.8	4.9	2.8	1.9	1.3	1.0	0.8	0.7	0.6	0.5	0.4	26.2	176.6
150/18	11.2	9.7	9.2	5.8	3.4	2.3	1.6	1.3	1.0	0.8	0.7	0.6	0.6	44.4	212.4
200/12	10.9	8.7	9.3	6.7	4.2	2.9	2.0	1.5	1.2	0.9	0.8	0.6	0.6	10.7	142.0
200/15	15.0	12.0	12.8	9.1	5.5	3.6	2.5	1.9	1.5	1.2	1.0	0.8	0.7	20.3	201.5
200/18	17.6	14.4	15.2	11.2	6.6	4.3	3.1	2.3	1.8	1.5	1.3	1.1	0.9	34.2	246.2
250/13	17.2	13.5	15.5	12.5	8.4	5.7	4.1	3.1	2.4	1.9	1.6	1.3	1.1	12.3	176.4
250/15	21.3	16.5	19.0	15.3	10.0	6.8	4.8	3.6	2.8	2.2	1.8	1.5	1.3	18.4	224.4
250/18	25.0	20.0	22.6	18.4	12.5	8.2	5.8	4.3	3.4	2.7	2.2	1.9	1.6	30.7	277.4
300/15	26.2	20.2	24.7	21.7	17.2	11.9	8.7	6.6	5.1	4.1	3.3	2.8	2.4	14.9	218.7
300/18	34.0	26.1	31.9	27.7	21.6	14.9	10.8	8.0	6.2	4.9	4.0	3.4	2.9	24.8	296.0
300/24	49.8	39.9	46.7	40.3	31.2	20.8	14.6	10.9	8.5	6.8	5.7	4.8	4.1	59.1	476.3
300/30	64.0	53.5	59.9	51.6	38.7	25.6	18.2	13.7	10.7	8.7	7.3	6.2	5.4	109.9	642.8
350/18	41.6	31.7	39.2	34.5	27.6	19.1	13.8	10.2	7.9	6.3	5.1	4.3	3.6	20.7	320.5
350/24	62.7	48.6	59.0	51.1	39.9	26.6	18.7	13.9	10.8	8.6	7.1	6.0	5.1	49.6	525.3
350/30	81.3	65.3	76.3	65.2	49.4	32.7	23.1	17.3	13.5	10.9	9.0	7.6	6.6	92.3	706.7
400/20	58.5	43.1	55.2	48.5	38.7	26.9	19.1	14.1	10.9	8.6	7.1	5.9	5.0	24.0	369.2
400/24	76.2	57.1	71.8	62.6	49.4	33.1	23.2	17.2	13.3	10.6	8.7	7.3	6.2	42.6	504.6
400/30	99.6	77.0	93.6	80.3	61.2	40.7	28.6	21.3	16.6	13.3	11.0	9.3	7.9	79.4	688.9

Notes:

- $\phi_b M_{sx}$ – Design section moment capacity about X axis.
- $\phi_b M_{dbx}$ – Design member moment capacity about X axis subject to distortional buckling.
- $\phi_b M_{fbx}$ – Design member moment capacity about X axis subject to lateral buckling. Values are based on the moment distribution of a uniform moment over entire unbraced segment at the centroid of **HST**. Refer to AS/NZS 4600 for the values of other moment distributions. No sheeting restraint has been considered in the calculation.
- $\phi_v V_v$ – Design shear capacity of **HST** webs without service holes.
- $\phi_c N_s$ – Design section capacity of the member in axial compression.
- The table should be used in conjunction with AS/NZS 4600.

DETAILING AND INSTALLATION

ORDERING

Orders may be placed at any Steel & Tube branch on the standard form. Purlin size and length must be specified, along with hole size and placement. Holes are in pairs, symmetrical about the longitudinal axis in the web, or centerline of the flange.

Delivery destination should be specified as it is the customer's responsibility to have unloading facilities available at time of delivery.

SECTION GEOMETRY

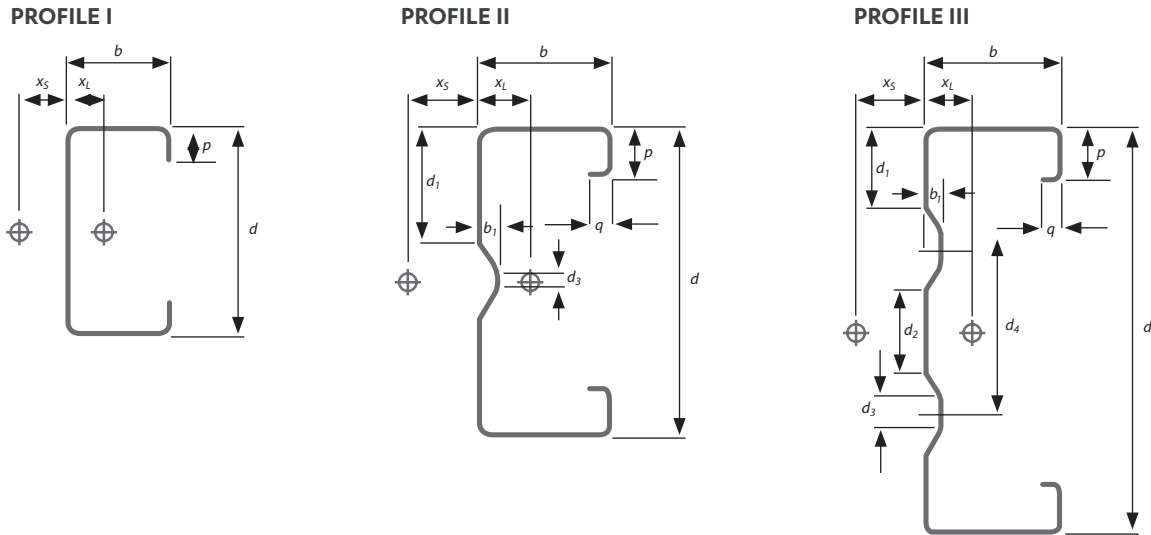

PURLIN DIMENSIONS

PROFILE	PURLIN SIZE HST	d MM	b MM	t MM	p MM	q MM	b ₁ MM	d ₁ MM	d ₂ MM	d ₃ MM	d ₄ MM	x _L MM	x _S MM	AREA A _s MM ²	MASS KG/M
I	100/12	102	51	1.15	15							16.8	24.9	253	2.03
	100/15	102	51	1.45	15							16.6	24.7	316	2.54
	100/19	102	51	1.85	15							16.4	24.4	400	3.23
II	150/12	152	65	1.15	24	10	8	59		7		23.5	33.3	386	3.03
	150/15	152	65	1.45	24	10	8	59		7		23.2	32.9	483	3.79
	150/18	152	65	1.75	24	10	8	59		7		23	32.6	578	4.56
III	200/12	203	75	1.15	25	12	8	59	10	10	48	25.1	35.2	478	3.80
	200/15	203	75	1.45	25	12	8	59	10	10	48	24.9	35.1	598	4.76
	200/18	203	75	1.75	25	12	8	59	10	10	48	24.6	34.9	717	5.72
	250/13	250	85	1.25	33	12	10	59	14	25	73	28.7	37.8	625	5.01
	250/15	250	85	1.45	33	12	10	59	14	25	73	28.6	37.7	722	5.79
	250/18	250	85	1.75	33	12	10	59	14	25	73	28.3	37.6	866	6.96
	300/15	300	100	1.45	38	12	10	59	64	25	123	32.1	45.3	847	6.72
	300/18	300	100	1.75	38	12	10	59	64	25	123	31.9	45.1	1018	8.08
	300/24	300	100	2.4	38	12	10	59	64	25	123	31.4	44.8	1382	11.01
	300/30	300	100	3	38	12	10	59	64	25	123	30.9	44.5	1711	13.71
	350/18	350	100	1.75	43	12	10	70	92	25	151	30.4	45.1	1123	8.96
	350/24	350	100	2.4	43	12	10	70	92	25	151	29.9	44.8	1526	12.08
	350/30	350	100	3	43	12	10	70	92	25	151	29.5	44.5	1891	15.05
400/20	400	100	1.95	48	12	10	75	132	25	191	29.1	45	1365	10.78	
400/24	400	100	2.4	48	12	10	75	132	25	191	28.8	44.8	1670	13.23	
400/30	400	100	3	48	12	10	75	132	25	191	28.3	44.4	2071	16.48	

Notes:

- All section properties are for the gross section.
- x_L = Centroid x_S = Shear Centre.

STANDARD HOLE LOCATIONS

HST100 (14mm holes only)

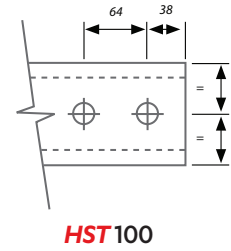
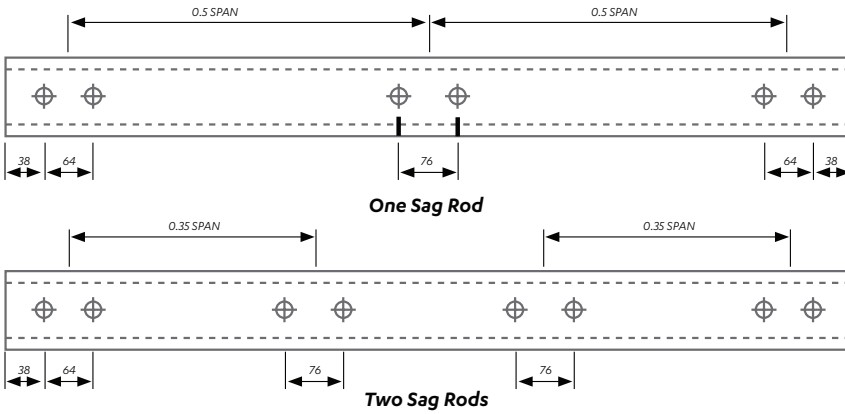

HST 150, HST 200, HST 250, HST 350, HST 400

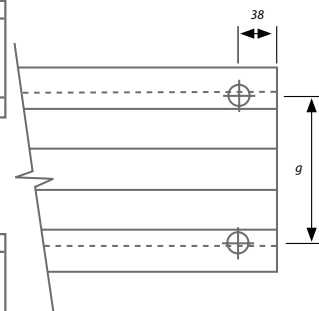
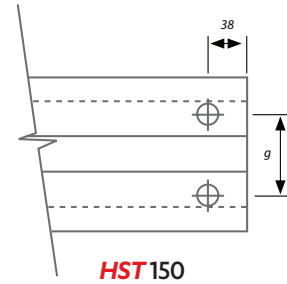
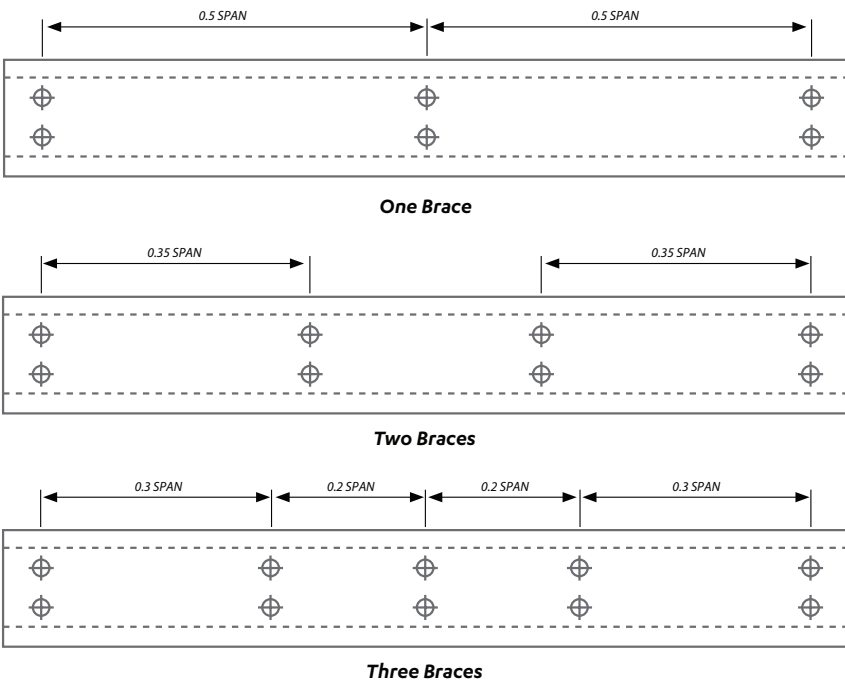

LAPPED PURLINS

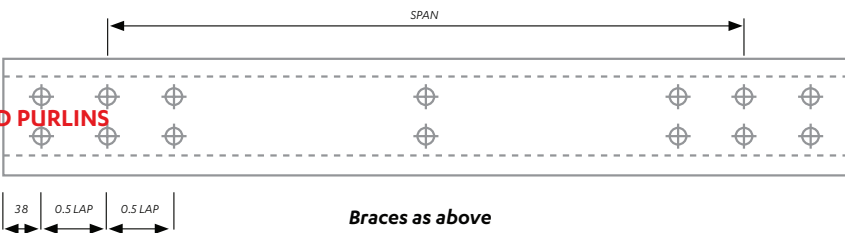

These details are indicative only. The designer shall verify the adequacy of brace setout for the scenario and loads present in their design.

BRACING

SPEED CHANNEL

Speed Channel is designed to fit purlins pre-punched with round 18mm diameter holes. The apex purlin has a bolted connection, thereafter hook connections are used to the eaves. The eaves purlin has a bolted connection which can be supplied adjustable if required. To maintain a continuous line, the eaves and apex purlins require holes offset 25mm each side of the nominal bracing line. Speed Channel bracing length should be calculated at the purlin spacing less 2mm.

SPEED CHANNEL BRACKETS

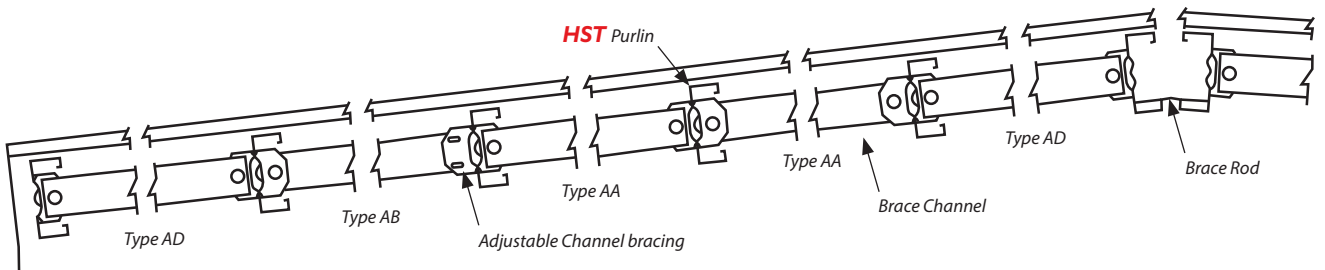
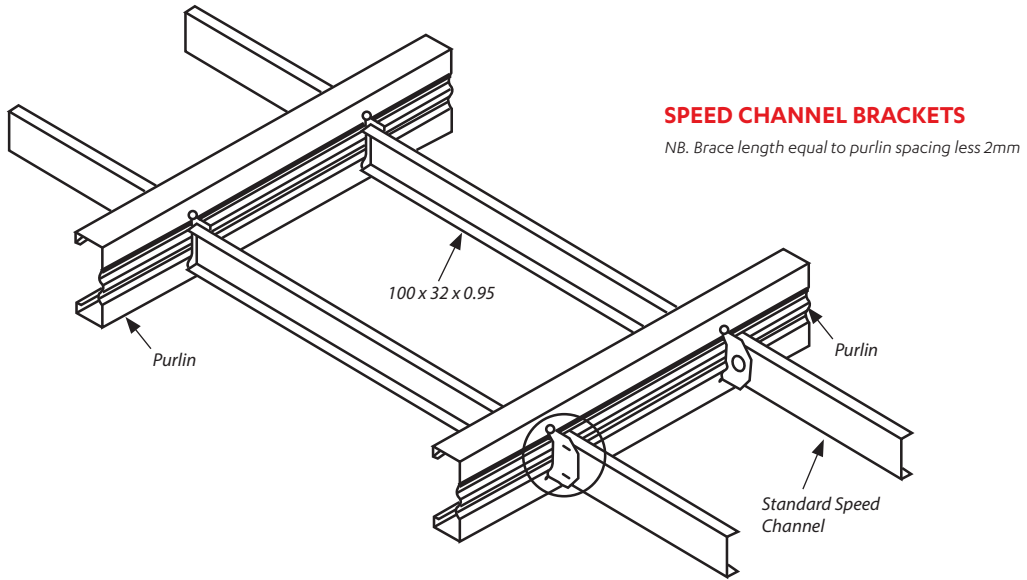

SPEEDBRACE END IDENTIFICATION

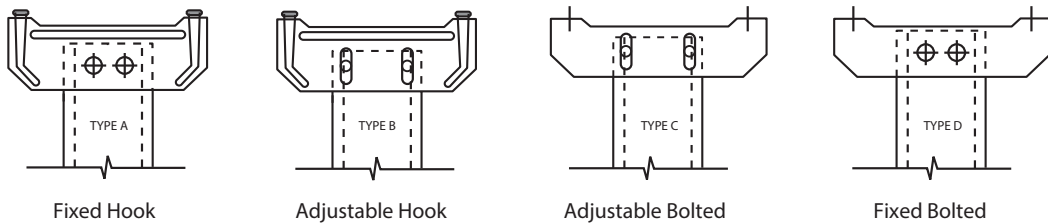

STANDARD CLEAT DETAILS

HST 100

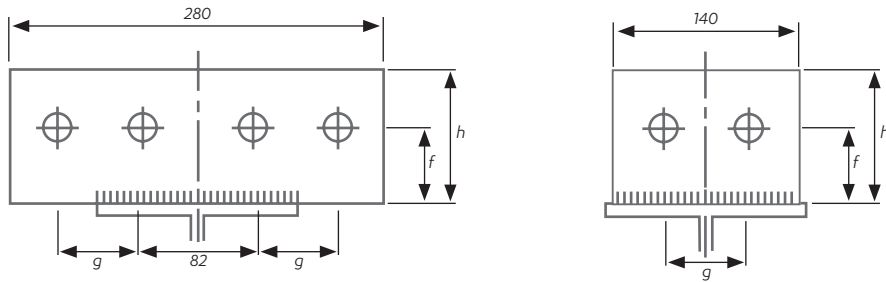

PURLIN	DIMENSIONS		
	f	g	h
HST 100	57	64	100
HST 150	41	80	150
HST 200	48	120	200
HST 250	53	160	250
HST 300	55	200	300
HST 350	60	240	340
HST 400	70	280	380

HST 150, 200, 250, 300, 350, 400

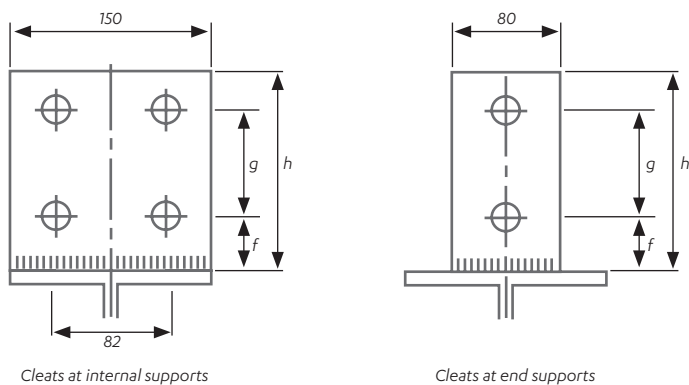

Cleats at internal supports

Cleats at end supports

FASTENING TO CLEATS

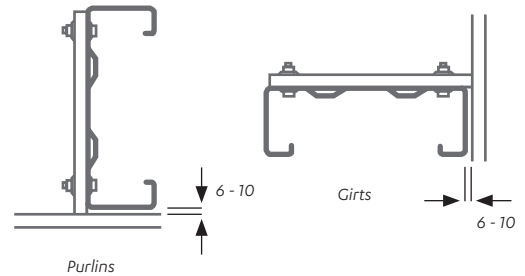

These details are indicative only. The designer shall verify the adequacy of cleats for the scenario and loads present in their design.

SITE HANDLING AND STORAGE

TRANSPORT AND HANDLING

CAUTION: Purlins may have sharp edges and appropriate gloves should be worn whenever handling.

Care should be taken when unloading and craning on site, and exclusion zones must be enforced.

Lengths up to 18 metres can be accommodated on our standard transport; longer lengths can be supplied subject to the cost and availability of suitable transport. Lengths will be supplied in bundles, and each bundle and purlin will have mark numbers inscribed.

Purlins must be unloaded without damaging the purlin or the zinc coating, and stored above ground on non-corrosive bearers.

Water entrapment between closely stacked galvanised surfaces can lead to white rust or wet storage stain, and premature consumption of the galvanised protective coating. If purlins become wet on site they must be separated before the appearance of white rust, to allow air access to all surfaces.

Corrosive matter such as grinding swarf, chemicals and site debris must be prevented from contacting and affecting the galvanised surface.



To find out more about our extensive range of products and services:

- › Steel
- › Pipe, Fittings & Valves
- › Stainless Steel
- › Fastenings
- › Chain & Rigging
- › Rural Products
- › Industrial Products
- › Reinforcing
- › Roofing, Cladding, Rainwater Systems & Purlins

CONTACT US TODAY:

0800 478 335

www.steelandtube.co.nz